

AQUAVAR® AV II

Variable Speed
Pump Control

Installation Programming & Operation



Models covered:
All AV2 Model
AQUAVAR II Controllers

software revision 120



Goulds Pumps



AQUAVAR II Controller Owner's Information Record

AQUAVAR II Controller Model _____ Transducer Model _____
AQUAVAR II Serial Number _____ Transducer Rating _____
Date purchased _____
Purchased from _____

Pump Model _____ Software Version _____
Pump Code Number _____





Program Record

Please use the following to record the final values programmed into the AQUAVAR controller after installation.

Required Value _____ (select) Level 2 _____ (%)
Autostart _____ (on/off) Intensity 1 _____ (%)
Password _____ (value) Intensity 2 _____ (%)
Window _____ (%) Pressure Increase _____ (PSI)
Ramp Hysteresis _____ (%) Pressure Decrease _____ (PSI)
Ramp 1 _____ (seconds) Enable Sequence Control _____ (Hz)
Ramp 2 _____ (seconds) Switch Interval _____ (hours)
Ramp 3 _____ (seconds) Optional Value _____
Ramp 4 _____ (seconds) Synchron Limit _____ (Hz)
Max. Frequency _____ (Hz) Synchron Window _____ (Hz)
Min. Frequency _____ (Hz) Pump Address _____ (# or off)
Config. F Min. _____ (F -> 0/F -> F min.) ADC Reference _____ (select)
Stop - Delay F Min. _____ (seconds) Freq. Lifting _____ (Hz)
Sensor Adjust _____ (out of range) Lift Intensity _____ (%)
Sensor Curve _____ (linear/quadratic) Analog out _____ (select)
Sensor Range - 20mA=362.6 _____ (PSI) Pressure Unit _____ (select)
Mode _____ (select) Test Run After _____ (in hours)
(actuator/controller/multicontroller/synch.) Test Frequency _____ (Hz)
Regulation Mode _____ (normal) Conveyor Limit _____ (PSI)
Start Value _____ (PSI) Delay Time _____ (seconds)
Config. Second Value _____ (off) Error Reset _____ (on/off)
Relay Config. _____ (run motor) Display Contrast _____ (%)
Offset Input _____ Lock Function _____ (on/off)
Level 1 _____ (%)

Index

Index

	System Design	5
	Important Safety Instructions	6
	Installation Procedures	9
	Materials Checklist	9
	1. Mounting the AQUAVAR II Controller	10
	2. Electrical Connections	12
	3. Pump Priming	28
	4. Run Test	28
	Programming	31
	1. The Main Menu - Setting One Pump Constant Pressure	31
	2. Single Pump - Pump Protection	33
	• To Set Run-Out Protection	34
	• To Set Low/No Flow Protection	34
	3. Single Pump - System Curve Compensation	38
	• Entering Compensation Values	39
	• Circulator Applications	41
	4. Single Pump Constant Flow	41
	5. Single Pump - Level Control Applications	43
	6. Single Pump - Submersible	44
	7. Setting a Second Required Value	46
	8. Variable Second Required Value	48
	9. Multiple Pump Constant Pressure and System Curve Compensation	53
	• Synchronous Control	56
	10. Multiple Pump - Pump Protection	59
	• To Set Low/No Flow Protection	59
	Operator Custom Features and Displays	61
	• Jog Mode	61
	• Window	61
	• Ramp Hysteresis	61
	• Ramp Settings	61
	• Ramp 1-4	62
	• Maximum Frequency	62
	• Minimum Frequency	63
	• Config. F Min	63
	• Stop-Delay F Min	63
	• Sensor Adjustment	63
	• Sensor Curve	63
	• Mode	63
	• Start Value	64
	• Config. Required Value 2	64
	• Relay Config.	64
	• Submenu Offset	64
	• Regulation Mode	64
	• Submenu Sequence Control	65
	• Actual Value Increase	65

Index

Index (*continued*)



Operator Custom Features and Displays (*continued*)

• Actual Value Decrease	65
• Enable Sequence Control	65
• Switch Interval	65
• Source Required Value	65
• Submenu Synchronous Control	65
• Synchronous Limit	65
• Synchronous Window	65
• Pump Sequence	66
• Bus	66
• Pump - Address	66
• ADC Reference	66
• Frequency Lifting	66
• Lift Intensity	66
• Reference	66
• Analog Out	67
• Pressure Units	67
• Test Run	67
• Submenu Test Run Manual	67
• Submenu Errors	67
• Clear Errors	68
• Operating Hours	68
• Total Run Time	68
• Display Contrast	68
• Set Password	68
• Lock Functions	68
• Heating On	68
• Default Values	68
• Save ??	68



Repair of Faults and Errors

• Lack of Water	69
• Conveyor Control	69
• Error 1-8	69
• Pressure Sensor Error	69
• Inverter Error	69
• External Device Error	70
• Active Fault / Warning and Fault History Mode	70
• Aquavar II Electrical Fault Codes	70



Programming Flow Chart



Help Windows

Appendix A - Pressure Transducer Data	81
• Technical Characteristics	84
Appendix B - AQUAVAR Controller Technical Data and Terminals	87
Appendix C - Interference Suppression Measures	89

System Design

System Design - Typical Constant Pressure Systems

Note

Systems MUST be designed by qualified technicians only.

The following diagrams show typical single pump and multi-pump systems using the AQUAVAR controller. Connection can be made directly to a water supply or water can be drawn from a supply tank or well. In the case of supply tanks and wells, level switches, (item 10) can be used to shut down the pumps when water is low. In the direct connection, a pressure switch on the suction side (item 8) can be used.

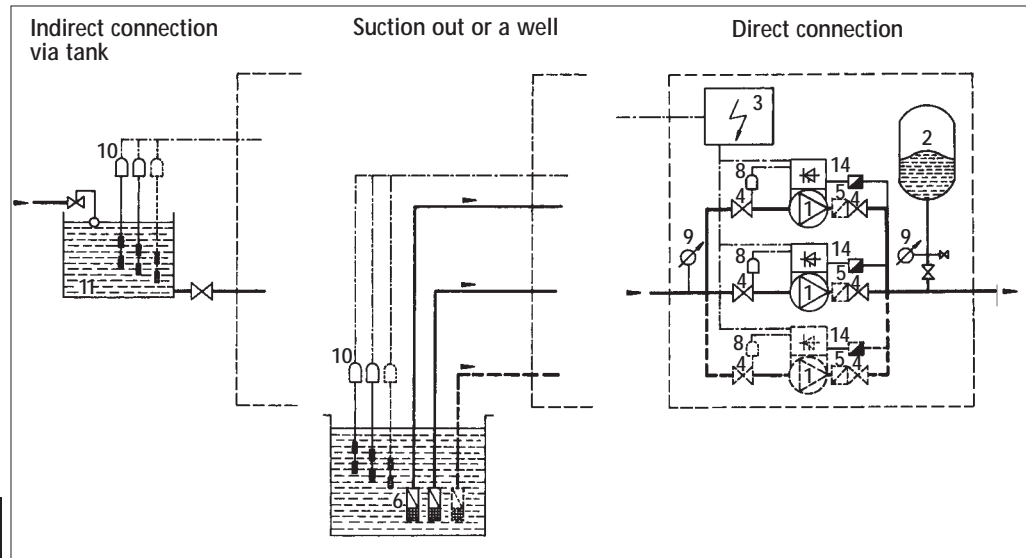

Diagram 1
Multiple Pump Layout

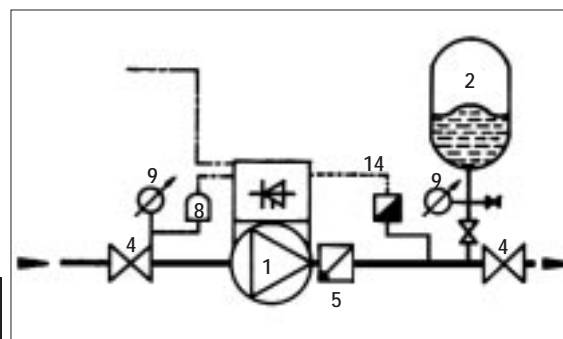

Diagram 2
Single Pump Layout

- 1 Pump with AQUAVAR controller
- 2 Diaphragm tank
- 3 Distribution panel
- 4 Gate valves
- 5 Check valves
- 6 Foot valves
- 8 Incoming pressure switch
- 9 Pressure gauges
- 10 Level switches
- 11 Supply tank
- 14 Pressure transmitter
(Included with AQUAVAR) *

A diaphragm pressure tank is used on the discharge side of the pump or pumps to maintain pressure in the line when there is no demand. This will keep the pumps from continuing to run. With the AQUAVAR controller, it is not necessary to have a large tank for supply purposes. In selecting a tank, make sure it can withstand maximum system pressure. The tank should have a capacity of at least 10% of the maximum system flow rate in gpm. Pre-charge the tank to the following:

PSI Set Pressure	15	30	45	60	75	90	105	120	135	150
PSI Tank Pre-charge	12	21	37	52	64	77	95	110	125	138

Note

Closed loop circulator systems may not require a pressure tank.

*Check with tank pressure limitations before precharge.

Safety Instructions



Important: Read all safety information prior to installation of the AQUAVAR controller.

Note



This is a **SAFETY ALERT SYMBOL**. When you see this symbol on the pump or in the manual, look for one of the following signal words and be alert to the potential for personal injury or property damage.



Warns of hazards that **WILL** cause serious personal injury, death, or major property damage.



Warns of hazards that **CAN** cause serious personal injury, death, or major property damage.



Warns of hazards that **CAN** cause personal injury or property damage.

NOTICE

Indicates special instructions which are very important and must be followed.

1. This manual is intended to assist in the installation, operation, and repair of the AQUAVAR controller and must be kept with the AQUAVAR controller.

Note

All operating instructions must be read, understood, and followed by the operating personnel. Goulds Pumps accepts no liability for damages or operating disorders which are the result of non-compliance with the operating instructions. When in doubt, call for assistance.

2. To avoid serious or fatal personnel injury or major property damage, read and follow all safety instructions in this manual.

Safety Instructions

Safety Instructions

3. Installation and maintenance **MUST** be performed by properly trained and qualified personnel.
4. Review all instructions and warnings prior to performing any work on the AQUAVAR controller.
5. Any safety decals **MUST** be left on the AQUAVAR controller unit and pump.

Note

Inspect AQUAVAR controller for any damage after unpacking from shipping crates. Report any damage immediately to the carrier or distributor/dealer immediately.

6. In addition to instructions contained in this manual, you must meet any local safety, electrical, or plumbing codes and requirements. Installation, maintenance, or repair work must only be carried out by trained, skilled, and qualified personnel, using proper protective gear and tools.
7. **The AQUAVAR controller drive head must be disconnected from the main power supply before attempting any operation in the electrical or mechanical part of the system.**

Note

When in operation, the motor can be stopped, but power remains at the drive head. The motor and pump could start unexpectedly and produce serious injury. When the AQUAVAR controller drive head is connected to the main power supply, the inverter power supply and master control unit are also connected to the power supply.



WARNING!

FAILURE TO DISCONNECT ELECTRICAL POWER BEFORE ATTEMPTING ANY MAINTENANCE CAN CAUSE SHOCK, BURNS, OR DEATH.

Safety Instructions

Note

TOUCHING THESE COMPONENTS SERIOUSLY ENDANGERS LIFE! Voltages of up to 800 volts are possible (higher if there is a fault).

Before removing the AQUAVAR controller drive top cover, the system must be disconnected from the main power supply. After switching off the power supply, you must wait at least 5 minutes before starting work on or inside the AQUAVAR controller drive head. This allows the capacitors in the circuit to be discharged by the discharge resistors.

8. The AQUAVAR controller has electronic safety devices which will stop the motor in the event of electrical or thermal faults. **This does not remove power to the AQUAVAR controller.**



WARNING!

FAILURE TO DISCONNECT AND LOCKOUT ELECTRICAL POWER AND WAIT FIVE MINUTES FOR CAPACITOR DISCHARGE BEFORE SERVICING AQUAVAR CONTROLLER CAN CAUSE SHOCK, BURNS, OR DEATH.

Note

Care must be taken when connecting external control wires and jumpers to avoid short circuit to neighboring components.

9. The system must be properly grounded before being put into operation. Use a common ground for the entire system.
10. High voltage tests of the AQUAVAR controller may damage the electronic components. Before carrying out such a test, bridge the incoming and outgoing terminals L1 - L2 - L3 - U - V - W. Isolate the motor from the AQUAVAR controller drive to avoid incorrect capacitor metering inside the AQUAVAR controller.

Note

Repair of electrical faults can lead to the automatic restart of the motor and pump. You must remove all main line power to the AQUAVAR controller before attempting to correct a fault.

Installation Procedures

Step 1- Identify Materials

The following materials are provided with the AQUAVAR II controller. Please familiarize yourself with each prior to installation.

Part	Quantity
1. AQUAVAR Controller	1
2. Pressure Transducer Assembly	1
a. Pressure transducer - 25 bar	1/4" NPT
b. Transducer adapter - (available as separate part only) See price book.	1/4" NPT female threads & 3/8 B male thread per UNI ISO/228/1 (British Standard pipe threads)
c. 30 ft. transducer cord (standard) for AV II.	

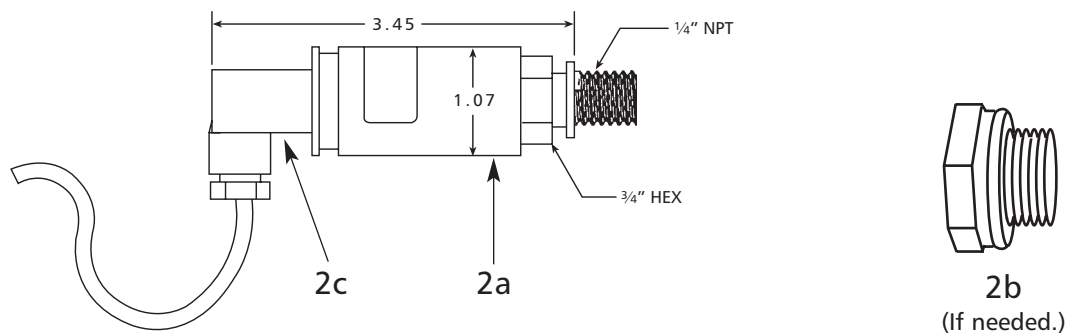

Note

YOU MUST USE THE CABLE THAT IS PROVIDED WITH THE TRANSDUCER. DO NOT USE DIFFERENT CABLES OR OLDER STYLE CABLES.

WARNING

THE AQUAVAR CONTROLLER AND PUMP MUST BE TOTALLY DISCONNECTED FROM ALL POWER SUPPLY SOURCES BEFORE BEGINNING INSTALLATION OR REPAIR.



WARNING!

FAILURE TO DISCONNECT ELECTRICAL POWER BEFORE ATTEMPTING ANY MAINTENANCE CAN CAUSE SHOCK, BURNS, OR DEATH.

Installation Procedures

Step 2 - Mounting the AQUAVAR II controller:

AQUAVAR Controller

The AQUAVAR controller may be installed as a wall or panel mounted unit. The AQUAVAR controller may be mounted up to 60 feet away from the pump motor*. In addition, alternative motor enclosures may be selected such as ODP, explosion proof or wash down motors in addition to the TEFC enclosure required for on the pump mounting.

Typical applications for the AQUAVAR Wall Mount controller include:

1. Hazardous environment applications including high heat, humidity or combustibility.
2. Installation to an existing pumping system with non-standard motors.
3. Installations where the operator desires all controls to be grouped together.

Mounting of the AQUAVAR II Controller

1. An alternative mounting style is used in the AQUAVAR II controller configuration. In this style, the AQUAVAR II controller is supplied with a fan and mounting bracket already installed and can be mounted to a wall or panel.
2. The mounting bolts for all units should be 1/4". The length of bolt and the strength of the mounting surface must be adequate to support the weight of the AQUAVAR II controller.
3. The AQUAVAR II controller may be positioned up to 60 feet from the pump motor. The pump motor must be three phase. Unlike the standard AQUAVAR controller, the motor may be ODP, TEFC or explosion proof.*
4. Mount the AQUAVAR controller to the panel, wall or frame using bolts at the points indicated on the following drawings. Be sure the unit is level and secured to the mounting surface before continuing.
5. Ensure plenty of airflow for the AQUAVAR controller, when mounting.

***NOTE:** If the AQUAVAR II controller is more than 60 feet wire length to motor, then the use of a load reactor (impedance coil) is required.

Installation Procedures

Step 2 - Mounting the AQUAVAR controller: *(continued)*

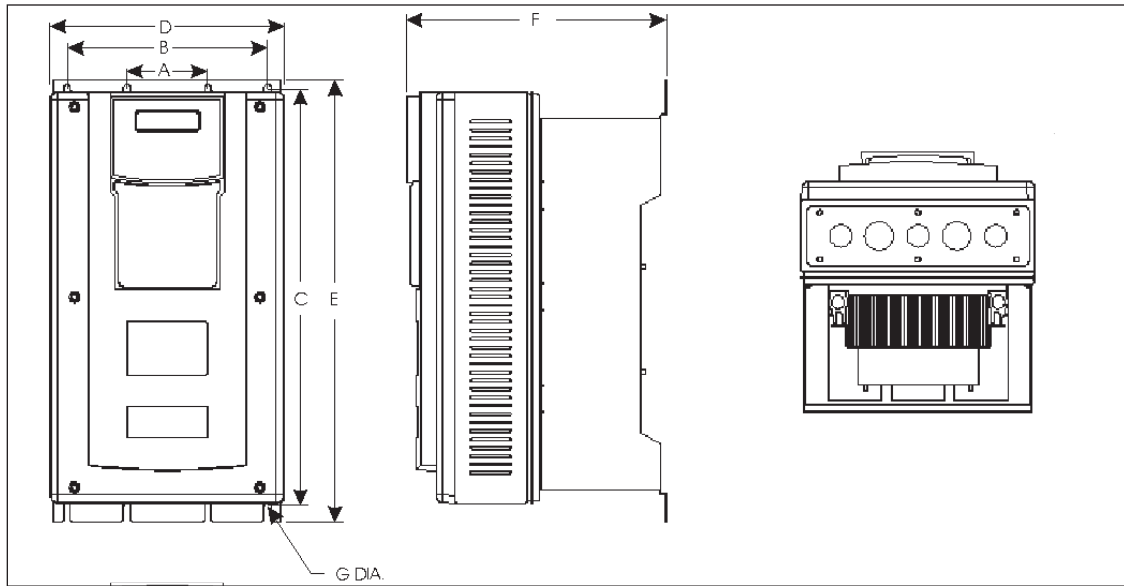

Diagram 3

HP Rating	A in (mm)	B in (mm)	C in (mm)	D in (mm)	E in (mm)	F in (mm)	G in (mm)
1 – 10 (230 – 3)	3.20	7.88	16.50	9.32	17.44	12.08	0.28
1 – 5 (230 – 1)	(81.28)	(200.15)	(419.10)	(236.70)	(442.98)	(306.71)	(7.11)
1 – 20 (575)							
15 – 20 (230 – 3)	3.20	7.88	19.25	11.44	20.19	13.51	0.28
7½ – 10 (230 – 1)	(81.28)	(200.15)	(488.95)	(290.53)	(512.83)	(343.20)	(7.11)
25 – 40 (460)							
25 – 40 (575)							
25 – 75 (460)	3.20	7.88	28.00	12.68	31.37	14.00	0.42
25 – 75 (575)	(81.28)	(200.15)	(711.20)	(322.07)	(796.80)	(355.60)	(10.67)

Note that the E-dimension in the 50-75 HP is maximum overall height to the conduit box rather than the bottom of the foot.

WEIGHTS OF MODELS - *Table 1: NEMA 12*

Power Rating	Weight	
	HP	Weight
	Pounds	Kilograms
1	24.0	10.9
2	24.0	10.9
3	24.0	10.9
5	24.0	10.9
7½	24.0	10.9
10	24.0	10.9
15	28.0	12.7
20	28.0	12.7

Installation Procedures

Power Rating HP	Weight	
	Pounds	Kilograms
25	52.0	23.6
30	52.0	23.6
40	60.0	27.2
50	107.0	48.6
60	107.0	48.6
75	107.0	48.6

Electrical Connections



 **WARNING!**
FAILURE TO DISCONNECT AND LOCKOUT ELECTRICAL POWER AND WAIT FIVE MINUTES FOR CAPACITOR DISCHARGE BEFORE SERVICING AQUAVAR CONTROLLER CAN CAUSE SHOCK, BURNS, OR DEATH.

Hazardous voltage can shock, burn or cause death.

Note

Installation and maintenance must only be performed by properly trained and qualified personnel equipped with the proper tools.

 **WARNING!**

-  **INSTALL, GROUND, AND WIRE ACCORDING TO LOCAL AND NATIONAL ELECTRICAL CODE REQUIREMENTS.**
-  **INSTALL AN ALL LEG DISCONNECT SWITCH NEAR THE MOTOR.**
-  **DISCONNECT AND LOCKOUT ELECTRICAL POWER BEFORE INSTALLING OR SERVICING.**

ELECTRICAL SUPPLY MUST MATCH PUMP'S AND AQUAVAR CONTROLLER NAME PLATE SPECIFICATIONS. INCORRECT VOLTAGE OR WIRING CAN CAUSE FIRE DAMAGE, AND VOIDS WARRANTY.

MOTORS WITH AUTOMATIC THERMAL PROTECTION MAY OPEN THEIR ELECTRICAL CIRCUIT WHEN A THERMAL OVERLOAD EXISTS. THIS CAN CAUSE THE MOTOR TO START UNEXPECTEDLY AND WITHOUT WARNING.

Installation Procedures

Electrical Connections continued

Step 3 - Preliminary Inspection

Before storing or installing the AQUAVAR controller, thoroughly inspect the device for possible shipping damage. Upon receipt:

1. Remove the controller from its package and inspect exterior for shipping damage. If damage is apparent, notify the shipping agent and your sales representative.
2. Remove the cover and inspect the controller for any apparent damage or foreign objects. Ensure that all mounting hardware and terminal connection hardware is properly seated, securely fastened and undamaged.
3. Read the technical data label affixed to the controller and ensure that the correct horsepower and input voltage for the application had been purchased.
4. If you will store the controller after receipt, place it in its original packaging and store in a clean, dry place free from direct sunlight or corrosive fumes, where the ambient temperature is not less than -20°C (-4°F) or greater than $+65^{\circ}\text{C}$ ($+149^{\circ}\text{F}$).

CAUTION!

EQUIPMENT DAMAGE HAZARD - DO NOT OPERATE OR INSTALL ANY CONTROLLER THAT APPEARS DAMAGED. FAILURE TO OBSERVE THIS INSTRUCTION CAN RESULT IN INJURY OR EQUIPMENT DAMAGE.

Step 4 - Installation Precautions

Improper installation of the AQUAVAR controller will greatly reduce its life. Be sure to observe the following precautions when selection a mounting location. **Failure to observe these precautions will void the warranty!**

1. Do not install the controller in a place subjected to high temperature, high humidity, excessive vibration, corrosive gases or liquids or airborne dust or metallic particles. See Technical Data Appendix B for temperature, humidity and maximum vibration limits or contact factory.
2. Do not mount the controller near heat-radiating elements or in direct sunlight.
3. Mount the controller vertically and do not restrict the air flow to the heat sink fins.
4. The controller generates heat. Allow sufficient space around the unit for heat dissipation.

Installation Procedures

Electrical Connections continued

Step 5 - Considerations for Mounting AQUAVAR Controllers in Host Enclosures

The AQUAVAR controller is available from stock in a variety of enclosures that meet the requirements of almost any application. Yet, special applications (such as use in washdown environments or in integrated systems) may make it desirable to mount AQUAVAR controllers in a host enclosure.

When the AQUAVAR controllers are mounted in a host enclosure, the watts dissipated by the drives must be dissipated by the host enclosure. If this is not accomplished, the control circuitry of the AQUAVAR controller will be damaged.

Two techniques are available for mounting AQUAVAR controllers in a host enclosure:

- The controllers may be entirely enclosed in the host enclosure or
- The controllers may be mounted with their cooling fins outside of the host enclosure.

The following sections discuss these two mounting techniques in greater detail.

Models Entirely Enclosed in the Host Enclosure

When an AQUAVAR controller is entirely enclosed in a host enclosure, the host enclosure must be properly sized to dissipate the heat generated by the controller and any other power-dissipated by the various models of the AQUAVAR controller at various switching frequencies. Use this information to adequately size the host enclosure.

Models with Fins External to the Host Enclosure

By mounting an AQUAVAR controller so that its heatsink fins are outside of the host enclosure, you may select a smaller host enclosure than that required when the controller is mounted entirely inside the host enclosure. For most applications with this type of mounting, typically you will not need such additional cooling devices as fans, heat exchangers or air conditioners.

The amount by which the load on the host enclosure is reduced is the amount of watts dissipated by the heatsinks of the controllers. Table 3 shows the watts dissipated by each AQUAVAR model after deducting the amount of watts dissipated by the heatsinks of the model. Use the values shown in the table to adequately size the host enclosure.

Installation Procedures

Electrical Connections continued

Table 2: Required Dissipation for Models Entirely Inside an Enclosure

AQUAVAR Model AV2V-	Switching Frequency			Max. Switching Frequency for Rated Current (kHz)
	Watts Dissipated at 4 kHz	Watts Dissipated at 7 kHz	Watts Dissipated at 10 kHz	
2S010D	37	44	51	10
2S020D	59	71	81	10
2S030D	77	92	106	10
2S050D	162	212	220	10
2S075D	195	251	271	10
2S100D	267	312	354	10
20010D	37	44	51	10
20020D	59	71	81	10
20030D	77	92	106	10
20050D	112	135	156	10
20075D	162	212	220	10
20100D	195	251 (1)	—	6
20150D	(2)	(2)	(2)	(2)
20200D	(2)	(2)	(2)	(2)
40010D	33	43	53	10
40020D	52	69	84	10
40030D	68	90	110	10
40050D	99	131	161	10
40075D	112	144	174	10
40100D	139	180	217	10
40150D	170	210	255 (1)	9
40200D	200	245	—	7
40250D	280	383	—	7
40300D	335	371 (1)	—	5
40400D	398 (1)	—	—	2.5
40500D	600	670 (1)	—	5
40600D	710 (1)	—	—	4
40750D	720 (1)	—	—	2
50010D	40	52	64	10
50020D	62	83	101	10
50030D	82	108	132	10
50050D	85	115	155	10
50075D	91	131	172	10
50100D	112	160	—	8
50150D	164	—	282 (1)	9
50200D	218	277 (1)	—	6
50250D	286	364 (1)	—	6
50300D	343	388 (1)	—	5
50400D	417	—	—	4
50500D	700	—	—	4
50600D	720 (1)	—	—	3
50750D	745 (1)	—	—	2

(1) Dissipation at rated current and maximum switching frequency.

Installation Procedures

Electrical Connections continued

Table 3: Required Dissipation When Fins are External to the Enclosure

AQUAVAR Model	Watts Dissipated
AV2V2S010D	19
AV2V2S020D	20
AV2V2S030D	27
AV2V20010D	19
AV2V20020D	20
AV2V20030D	27
AV2V20050D	29
AV2V20070D	36
AV2V20100D	34
AV2V20150D	68
AV2V20200D	73
AV2V40010D	20
AV2V40020D	21
AV2V40030D	27
AV2V40050D	30
AV2V40070D	36
AV2V40100D	40
AV2V40150D	46
AV2V40200D	50
AV2V40250D	75
AV2V40300D	76
AV2V40400D	80
AV2V40500D	134
AV2V40600D	145
AV2V40750D	150
AV2V50010D	20
AV2V50020D	21
AV2V50030D	27
AV2V50050D	30
AV2V50070D	33
AV2V50100D	39
AV2V50150D	43
AV2V50200D	44
AV2V50250D	73
AV2V50300D	78
AV2V50400D	82
AV2V50500D	135
AV2V50600D	143
AV2V50750D	152

Installation Procedures

Electrical Connections continued

Step 6 - Maintenance

Minimum Torque Values to Secure Cover

If you remove the cover of an IP55 AQUAVAR controller, it is imperative that the cover be closed and re-secured with sufficient tightness to maintain environmental integrity. The table below specifies the torque values for the bolts that secure the covers on the various models.

AV2 Enclosure Type		Torque Value	
		English	Metric
IP55	1-20 HP, 230 Vac input	12 in-lbs	1.35 Nm
	1-20 HP, 460 and 575 Vac input	18 in-lbs	2.03 Nm
	25-75 HP, 460 and 575 Vac input	12 in-lbs	1.35 Nm

Step 7 - General Wiring Information

Wiring Practices

When making power and control connections, observe these precautions:

- Follow all Federal, State, NEC codes and local codes.
- **Never** connect input AC power to the **motor output terminals** T1/U, T2/V or T3/W – or damage to the controller will result.
- Power wiring to the motor must have the maximum possible separation from all other power wiring. Do not run in the same conduit, this separation reduces the possibility of coupling electrical noise between circuits.
- Cross conduits at right angles whenever power and control wiring cross.
- Good wiring practice also requires separation of control circuit wiring from all power wiring. Since power delivered from the controller contains high frequencies which may cause interference with other equipment, do not run control wires in the same conduit or raceway with power or motor wiring.

Considerations for Power Wiring

Power wiring refers to the line and load connections made to terminals L1/R, L2/S, L3/T and T1/U, T2/V, T3/W respectively. Select power wiring as follows:

- Use only UL recognized wire. (Shielded or armored wire is recommended for power and motor wiring.)
- Wire voltage rating must be a minimum of 300 V for 230 Vac systems and 600 V (Class 1 wire) for 460 Vac and 575 Vac systems.

Installation Procedures

Electrical Connections continued

- Use circuit breakers on the incoming power lines.
- Grounding must be in accordance with NEC and CEC. If multiple AQUAVAR controllers are installed near each other, each must be connected to ground. Take care to not form a ground loop. Maintain a common ground.
- Wire must be made of copper and rated 60 / 75°C (unless otherwise specified in the table below). Refer to Tables 4, 5 and 6 for recommended wire gauges and temperature ratings.

Considerations for Control Wiring

Control wiring refers to the wires connected to the control terminal strip. Select control wiring as follows:

- Shielded wire is recommended to prevent electrical noise interference from causing improper operation or nuisance tripping.
- Use only UL™ recognized wire.
- Wire voltage rating must be at least 300 V for 230 Vac systems.

Table 4: Recommended Wire Gauges (230 Vac Models)

Model Number	Wire Size 208 Vac		Wire Size 230 Vac	
	AWG	mm ²	AWG	mm ²
AV2V2S010D	14	2.5	14	2.5
AV2V2S020D	12	4.0	12	4.0
AV2V2S030D	10	6.0	10	6.0
AV2V2S050D	8	10.0	8	10.0
AV2V2S075D	6	16.0	6	16.0
AV2V2S100D	4	25.0	4	25.0
AV2V20010D	14	2.5	14	2.5
AV2V20020D	14	2.5	14	2.5
AV2V20030D	12	4.0	14	2.5
AV2V20050D	10	6.0	10	6.0
AV2V20070D	8	10.0	8	10.0
AV2V20100D	8 ¹	10.0 ¹	8	10.0
AV2V20150D	6 ¹	16.0 ¹	6 ¹	16.0 ¹
AV2V20200D	6 ¹	16.0 ¹	6 ¹	16.0 ¹

(1) Use wire rated 90°C in an environment where the ambient temperature is greater than 40°C (122°F).

Installation Procedures

Electrical Connections continued

Table 5: Recommended Wire Gauges (460 Vac Models)

Model Number	Wire Size	
	AWG	mm ²
AV2V40010D	14	2.5
AV2V40020D	14	2.5
AV2V40030D	14	2.5
AV2V40050D	14	2.5
AV2V40075D	12	4.0
AV2V40100D	12	4.0
AV2V40150D	10	6.0
AV2V40200D	10 ¹	6.0 ¹
AV2V40250D	8 ¹	10.0 ¹
AV2V40300D	6 ¹	16.0 ¹
AV2V40400D	6 ¹	16.0 ¹
AV2V40500D	3 ¹	35.0
AV2V40600D	2 ¹	35.0 ¹
AV2V40750D	1 ¹	50.0 ¹

(1) Use wire rated 90°C in an environment where the ambient temperature is greater than 40°C (122°F).

Table 6: Recommended Wire Gauges (575 Vac Models)

Model Number	Wire Size	
	AWG	mm ²
AV2V50010D	14	2.5
AV2V50020D	14	2.5
AV2V50030D	14	2.5
AV2V50050D	14	2.5
AV2V50075D	14	2.5
AV2V50100D	12	4.0
AV2V50150D	10	6.0
AV2V50200D	8	10.0
AV2V50250D	8	10.0
AV2V50300D	8	10.0
AV2V50400D	6 ¹	16.0 ¹
AV2V50500D	4 ¹	25.0 ¹
AV2V50600D	4 ¹	25.0 ¹
AV2V50750D	2 ¹	35.0 ¹

(1) Use wire rated 90°C in an environment where the ambient temperature is greater than 40°C (122°F).

Installation Procedures

Electrical Connections continued

Step 8 - Input Line Requirements

Line Voltage

See the Power and Current Ratings table for the allowable fluctuation of AC line voltage for your particular model. A supply voltage above or below the limits given in the table will cause the drive to trip with either an overvoltage or undervoltage fault.

When supplying line voltages other than the factory default values (either 230 Vac, 460 Vac or 575 Vac depending on the model), set the **Supply Voltage** parameter to the appropriate value.

Exercise caution when applying the AQUAVAR controller on low-line conditions.

For example, an AQUAVAR controller will operate properly on a 208 Vac line – but the maximum output voltage will be limited to 208 Vac. Now if a motor rated for 230 Vac line voltage is controlled by this drive, higher motor currents and increased heating will result.

Therefore, ensure that the voltage rating of the motor matches the applied line voltage. If other than 60 Hz output is desired, proper V/Hz can be programmed into the AVII by setting the **Nom Mtr Voltage** and **Nom Mtr Freq** parameters.

Use of Isolation Transformers and Line Reactors

The AQUAVAR controller is perfectly suitable in most cases for direct connection to a power source as specified in this manual and the technical nameplate affixed to the unit. There are however a few cases where a properly sized isolation transformer or line reactor should be employed to minimize the risk of drive malfunction or damage or nuisance tripping:

- As noted in *Table 7*, transformer sizing, when line capacity is greater than 10 times the KVA rating of the drive. Consult the factory for assistance in sizing the reactor.
- When power factor correction capacitors are employed on the drive's power source.
- When the power source is known to be subject to transient power interruptions or significant voltage spikes.
- When the power source supplying the drive also supplies large devices such as DC drives that contain controller rectifiers.

Table 7: Transformer Sizing for the AQUAVAR Controller

Controller HP	1	2	3	5	7.5	10	15	20	25	30	40	50	60	75
Transformer kVA	2	4	5	9	13	18	23	28	36	42	56	70	90	112

Installation Procedures

Electrical Connections continued

Phase Imbalance

Phase voltage imbalance of the input AC source can cause unbalanced currents and excessive heat in the drive's input rectifier diodes and DC bus capacitors. Phase imbalance can also damage motors running directly across the line.

CAUTION!

EQUIPMENT DAMAGE HAZARD - NEVER USE POWER-FACTOR CORRECTION CAPACITORS ON MOTOR TERMINALS T1/U, T2/V OR T3/W. DOING SO WILL DAMAGE THE SEMICONDUCTORS. FAILURE TO OBSERVE THIS INSTRUCTION CAN RESULT IN INJURY OR EQUIPMENT DAMAGE.

Step 9 - Terminals Found on the Power Board

Description of the Terminals

Diagram 4 shows the power terminals for the AQUAVAR controller. Table 8 describes the terminals.

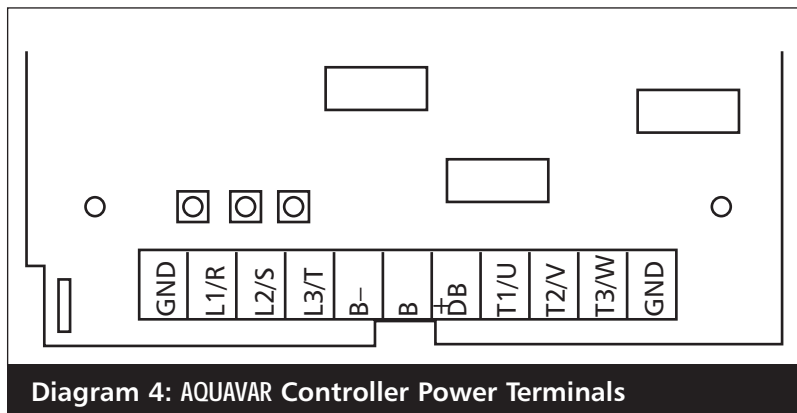

Table 8: Description of Power Terminals

Terminal	Description
TB1 Terminal Group	
GND	Earth ground.
L1/R L2/S L3/T	These terminals are the line connections for three-phase models. (Single-phase models will only have the L1/R terminal, with the other two terminals being replaced by a terminal labeled N.)
T1/U T2/V T3/W	These terminals are for motor connections.

Installation Procedures

Electrical Connections continued

Typical Power Connections

Diagram 5 shows the terminal connections for line power and motor output. See Step 8 for input line requirements.

Note that when testing for a ground fault, do not short any motor lead (T1/U, T2/V or T3/W) back to an input phase (L1/R, L2/S or L3/T).

As shown in Diagram 5, it is necessary to provide fuses and a disconnect switch for the input AC line in accordance with all applicable electrical codes. The drive is able to withstand a 110% overload for 60 s. For maximum protection of the drive, use the fuses listed in Tables 9, 10 and 11 found below and on the next page. The recommended supplier is Bussman.

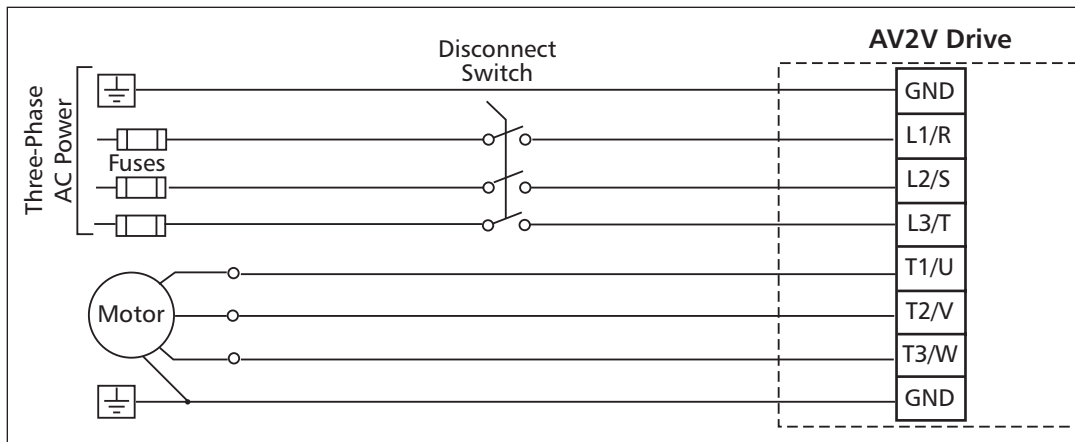

Diagram 5: Connections for Power Wiring

Table 9: Recommended Fuses (230 Vac Models)

Model Number	Fuse Size 208 Vac JJS/JJN ¹	Fuse Size 230 Vac JJS/JJN ¹
AV2V2S010D	15	10
AV2V2S020D	20	20
AV2V2S030D	30	30
AV2V2S050D	45	45
AV2V2S075D	60	60
AV2V2S100D	80	80
AV2V20010D	10	6
AV2V20020D	15	10
AV2V20030D	20	15
AV2V20050D	30	25
AV2V20075D	40	35
AV2V20100D	50	40
AV2V20150D	70	60
AV2V20200D	70	60

(1) For sizes up to and including 30 A, KTK fuses may be substituted.

Installation Procedures

Electrical Connections continued

Table 10: Recommended Fuses (460 Vac Models)

Model Number	Fuse Size 380 Vac JJS/JJN ¹	Fuse Size 460 Vac JJS/JJN ¹
AV2V40010D	6	6
AV2V40020D	6	6
AV2V40030D	10	10
AV2V40050D	15	15
AV2V40075D	20	20
AV2V40100D	20	20
AV2V40150D	40	35
AV2V40200D	50	40
AV2V40250D	60	50
AV2V40300D	70	60
AV2V40400D	80	60
AV2V40500D	90	90
AV2V40600D	110	110
AV2V40750D	150	150

(1) For sizes up to and including 30 A, KTK fuses may be substituted.

Table 11: Recommended Fuses (575 Vac Models)

Model Number	Fuse Size 575 Vac JJS/JJN ¹
AV2V50010D	6
AV2V50020D	6
AV2V50030D	10
AV2V50050D	10
AV2V50075D	15
AV2V50100D	20
AV2V50150D	30
AV2V50200D	35
AV2V50250D	50
AV2V50300D	50
AV2V50400D	70
AV2V50500D	70
AV2V50600D	80
AV2V50750D	100

(1) For sizes up to and including 30 A, KTK fuses may be substituted.

Installation Procedures

Electrical Connections continued

- The wires routed from the terminal block U, V, W, and ground screw, should now be connected to the motor leads using the motor nameplate and Diagram 6 for reference. Always refer to motor wiring nameplate.
- Pressure Transducer Installation and Wiring**

It is recommended that the transducer be mounted in the

discharge piping. The location should be in a non-turbulent, straight piece of pipe. See layout on page 5. Locate the adapter for the pressure transducer, if needed.

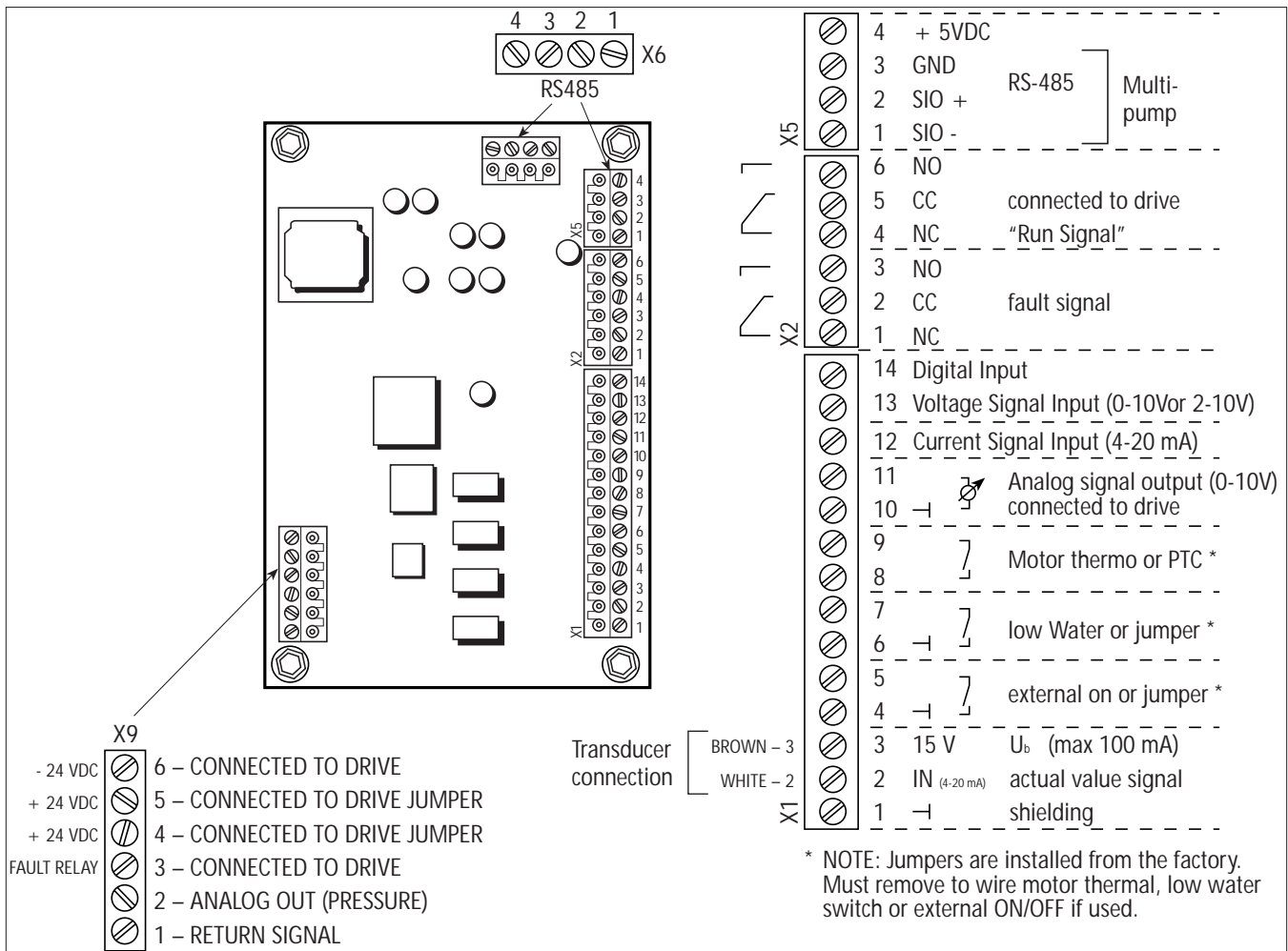
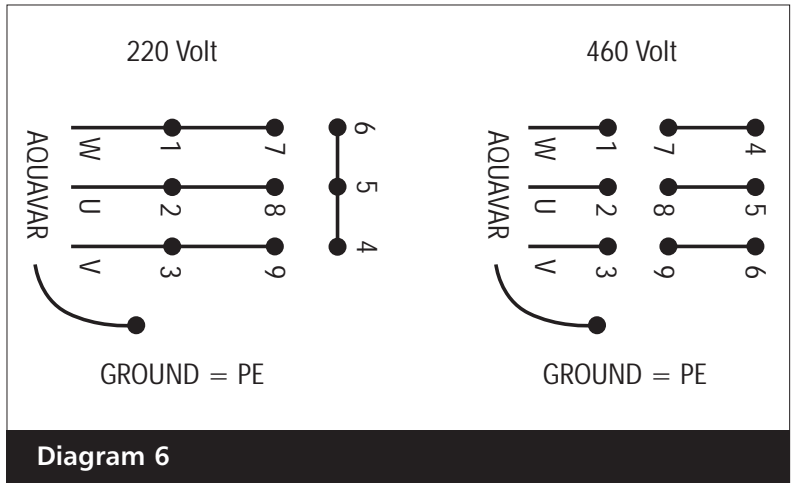

Diagram 7

Installation Procedures

Electrical Connections continued

- Place the square gasket over the end of the transducer, plug the cable connector on, and tighten the screw.
 - The transducer is supplied with 1/4" NPT threads for direct mounting in the discharge piping.

Note

Cable connector will fit on one way only! Do not force on or damage may occur.

- Now select one of the remaining ports in the AQUAVAR controller to route the transducer cable. Route the transducer cable through the strain relief, cut to length and connect to locations X1 #2 and #3 as shown in Diagram 7. (Note: Control board is mounted to the inside front cover of the drive enclosure.) The brown wire is connected to X1 #3 and the white wire to X1 #2. Tighten strain relief.

5. Terminals Found on the AV II Drive Control Board (Internal Drive)

Description of the Control Terminals: Figure 8 shows the control terminals found on the I/O board of the AV II drive. (The actual control board cannot be accessed by the user.) These terminals are prewired by the factory with color coded wires below.

Note that due to labeling constraints, the labels for some terminals start on the left (either on the side or top of the terminal block), are interrupted by the terminal screw, and then finish on the right (either on the side or top of the terminal block). For example, terminal A11 is labeled with A on the left side of the block and 11 to the right of the terminal screw on top of the block. Similarly, terminal NC2 is labeled with N to the left of the terminal screw on top of the block and then C2 on the right side of the block.

As is shown in the figure, the terminals are divided into four terminal blocks, each of which pulls apart for ease of field wiring:

- TB1 - analog input, analog output and digital output terminals.
- TB2 - output relay 1 (R1).
- TB3 - output relay 2 (R2).
- TB4 - digital input terminals.

Table 12 starting on the next page describes the control terminals.

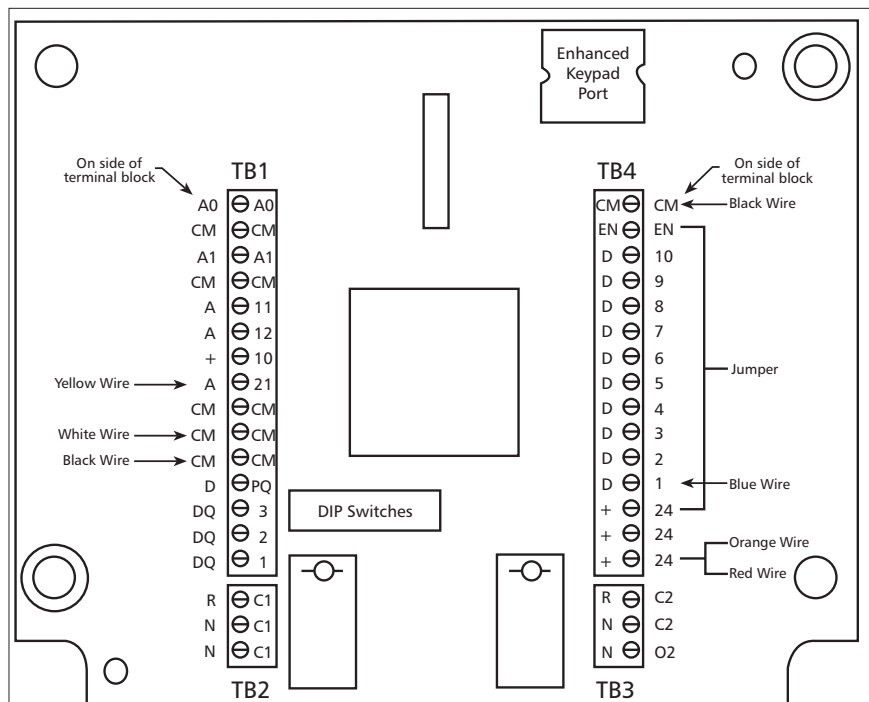

Diagram 8

Installation Procedures

Electrical Connections continued

Table 12: Description of AV II Drive Control Terminals (Internal Drive)

Terminal	Description
TB2 Terminal Block	
RC1	Common terminal for the first auxiliary relay. The function of the relay is set by parameter R1 Configure. The default setting is for the relay to activate when a fault is detected (Drv Flted).
NC1	Normally-closed contact for the first auxiliary relay. It will open when the relay is activated.
NO1	Normally-open contact for the first auxiliary relay. It will close when the relay is activated.
TB3 Terminal Block (Drive Run Contacts)	
RC2	Common terminal for the second auxiliary relay. The function of the relay is set by parameter ROUT R2 Config . The default setting is for the relay to activate when the drive is running. The contact ratings are 115 VAC at 1 A or 230 VAC at 0.5 A.
NC2	Normally-closed contact for the second auxiliary relay. It will open when the relay is activated.
NO2	Normally-open contact for the second auxiliary relay. It will close when the relay is activated.
TB4 Terminal Block	
EN	Enable terminal. A jumper is placed between this terminal and the +2 terminal at the factory. You may replace this with a contact if desired. The circuit from EN to +24 must be closed for the drive to operate. Note that unlike all other terminals, this terminal cannot be configured for "pull-down logic." That is, a high input to this terminal is always regarded as true – and must be present if the drive is to operate.
D3 to D10	Digital inputs. The function of a digital input is configured by the parameter with the same name as the digital input in the DI Configure parameter group.
D2	Digital input. In 3-wire control, this must be a Stop input. In 2-wire control, it may be configured to another function with parameter D2 Configure .
D1	Digital input. This must be a Start or Run input.

Installation Procedures

6. For multi-pump systems: Use a three core shielded cable to connect terminals 1, 2, and 3 on X5 between the AQUAVAR controller units. These are the RS-485 interface connections. (See Diagram 11 and 13). **Note:** either RS485 port can be used.
- Connect pump one to pump two, two to three, and three to four (maximum is 4 pumps).

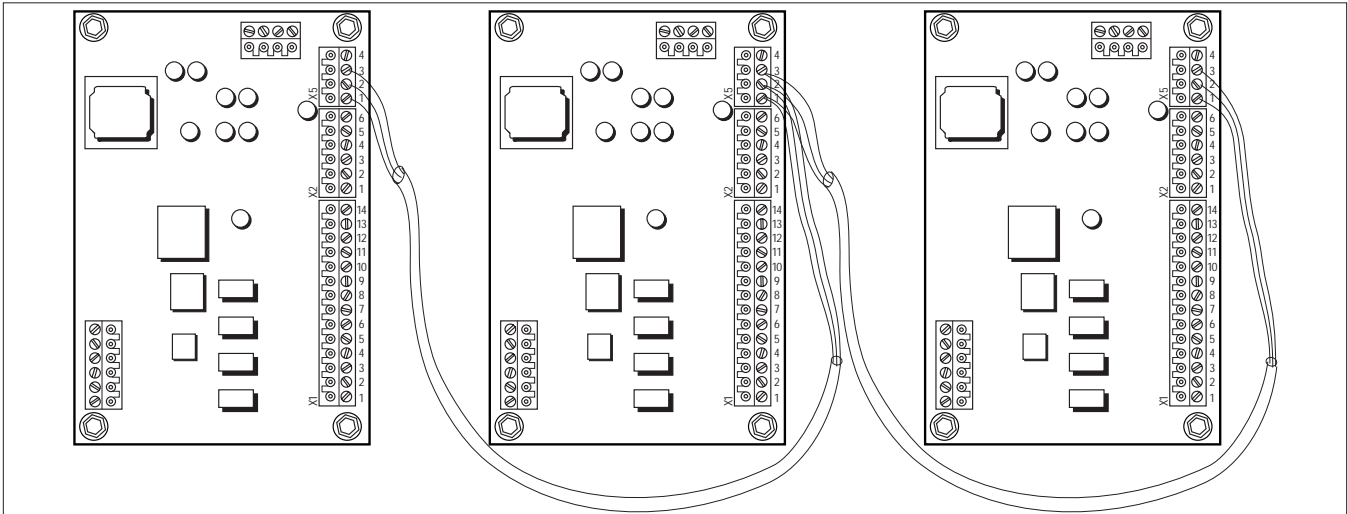

Diagram 9

7. External pressure switch or float switch- (if used) to check incoming pressure and low/no suction. Connect to terminal block X1 at the 6 and 7 location. Refer to Diagram 11.
When using a suction pressure switch, set the cut off at the maximum NPSH required by the pump.

Note

If an external switch is NOT used, install a jumper wire between X1 Locations 4 and 5.

8. External on/off

If used to turn the AQUAVAR controller on or off from an external panel or controller, connect to terminal block X1 at the 4 and 5 location (refer to Diagram 7, page 24).

9. Analog output of pressure

A meter can be connected to X9 pins 2 and 1 for remote display of actual system pressure. The meter must be 0-10 VDC volt with no more than 2 mA.

10. Second Sensor Input

The ground pin (X1-10) used for analog output can also be used to bridge a connection for a second sensor. This can be digital (on/off) such as a switch which would be connected between X1-10 and X1-14. Another choice is a sensor with a voltage signal of 0-10V or 2-10V which would be connected to X1-10 and X1-13. A final choice is a 4-20 mA current sensor which would be connected to pins X1-10 and X1-12.

Note

Power supplies using G.F.I. breakers will cause nuisance tripping which will result in the AQUAVAR controller displaying an "undervoltage" fault.

Installation Procedures

Pump Priming

Refer to your pump operation manual for instructions on pump priming. You will need to unscrew the pressure transducer and adapter if you used the pump fill plug for mounting. When priming is complete, replace the pressure transducer and check for leaks!

Run Test

WARNING

DO NOT APPLY POWER TO THE AQUAVAR CONTROLLER OR PUMP UNTIL ELECTRICAL CONNECTIONS HAVE BEEN REVIEWED BY A QUALIFIED ELECTRICIAN AND MEET ALL APPLICABLE STATE AND LOCAL REQUIREMENTS.

Instructions

1. Check all wiring.

All motors used with the AQUAVAR controller are three phase. You will need to check the direction of rotation of the motor shaft. If you have followed all of the previous steps carefully, you should now be ready to apply power to the AQUAVAR controller unit.

2. Close discharge valve.

Make sure the discharge valve is closed. Apply power to the AQUAVAR controller. The first screen appears for 2 seconds and shows the software version and manufacture date. The next screen will appear automatically
**If auto start is preprogrammed "ON", pump will start immediately.*

3. Check Power Light

Check the AQUAVAR controller panel. The **"power on"** light should be illuminated and the display should say **"No Autostart - disable inverter."** If either of these conditions is not present, turn off all power to the AQUAVAR controller and recheck all connections.

Screen

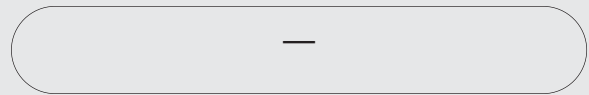

ITT Industries
SW:120

Date: 10/30/00

NO AUTOSTART - DISABLE INVERTER



WARNING!

FAILURE TO DISCONNECT AND LOCKOUT ELECTRICAL POWER AND WAIT FIVE MINUTES FOR CAPACITOR DISCHARGE BEFORE SERVICING AQUAVAR CONTROLLER CAN CAUSE SHOCK, BURNS, OR DEATH.

Note

To change the display language on the AQUAVAR controller, press the **"*** key and the up arrow key at the same time. A scrolling line will appear on the bottom of the screen and tell you which button to push for the language you want. After selecting the language, press the up arrow to return to the main display.

Installation Procedures

4. Check Display.

*** If these conditions exist, proceed. If NOT, check all wiring.**

Screen

NO AUTOSTART - DISABLED INV.

5. Drive Component Keypad (Internal Drive)

The AQUAVAR II units have an additional keypad inside the cabinet. You will need to use this keypad one time for initial system set up. Once set, all other functions are programmed with the main display on the front panel. Below are the instructions for initial programming of the internal keypad.

This keypad provides access to a comprehensive set of parameters that allow the AV II drive to meet the needs of almost any application. To make customization as simple as possible, two levels of programming are available.

Programming Mode

- A. Programming mode is entered by pressing the **PROG** key.
- B. To program a parameter's value, perform the following steps:
- C. Press **PROG** to initiate programming.
- D. The Operate display will change to the list of parameters. An arrowhead indicates which one is selected.
- E. If the desired parameter is indicated by the arrowhead, press **ENTER** to select the parameter and display its current value. If the indicated parameter is not the one you want to program, use the up or down arrow keys to move the arrowhead to the desired parameter and then press **ENTER** to select the parameter and display its current value.
- F. After the **ENTER** key is pressed, the value for the parameter will be displayed. For example, parameter Motor voltage may range from 100V to 690 V and you may configure any value within that range as shown on the motor nameplate.

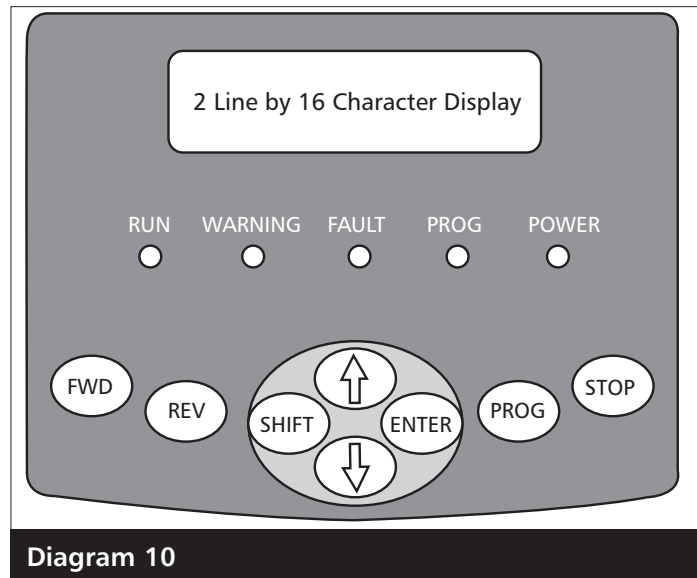

Diagram 10

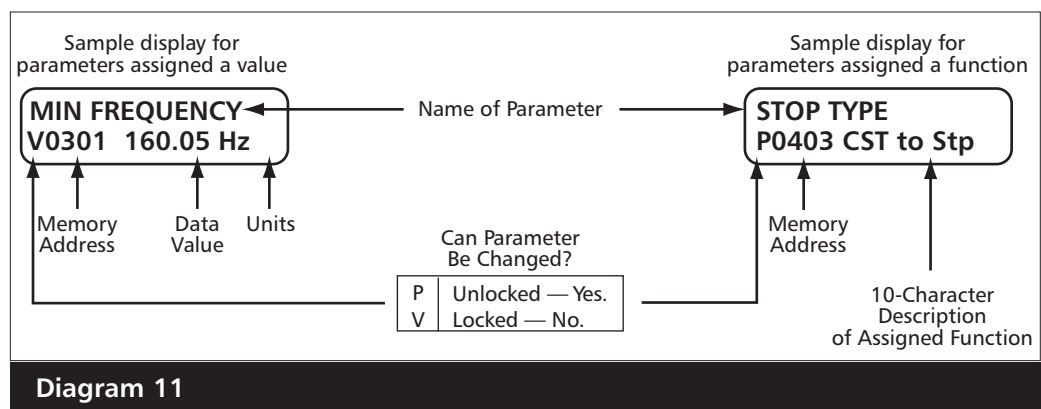
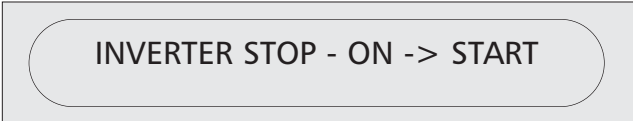

Diagram 11

Installation Procedures *(continued)*

- G. Use the up or down arrow keys to change the parameter's value to the desired value.
 - H. Press **ENTER** to save the new value. (If you do not wish to save the new value, press **SHIFT**.)
 - I. The new value is stored, or discarded, and then the list of parameters is shown.
 - J. You may now select another parameter or return to the Operate mode by pressing the **PROG** key.
6. You need to set up the AQUAVAR controller for the type of pump motor you are using. Press the **PROG** key to display the list of functions. Use the up or down arrow to scroll to the NOM MTR CURRENT parameter.
 7. Press the **ENTER** key and then the up and down arrows to change the value to match the SFA (Service Factor Amps) shown on your pump motor data plate. Once complete, press **ENTER** again. (Maximum S.F. amps is 10% above nominal controller output amps.) See *pages 86 and 87*.
 8. Scroll to the NOM MTR VOLTAGE parameter and press **ENTER**. Use the up and down arrows to enter the voltage on the motor nameplate. For multi-voltage motors, select the voltage to match your line voltage. Press **ENTER** to save the value.
 9. Scroll to the NOM MTR FREQ parameter and press **ENTER**. Use the up and down arrows to enter the maximum frequency for the motor design you are using. This would be either 50 Hz or 60 Hz. Press **ENTER** to save the value.
 10. Scroll to the NOM MTR RPM parameter and press **ENTER**. Use the up and down arrows to enter the maximum RPM for the motor you are using. This can be found on the motor nameplates. Press **ENTER** to save the value.
 11. Scroll to the SUPPLY VOLTAGE parameter. Press **ENTER** and use the up and down arrows to put in the voltage available on the input line. Press **ENTER** to save the value.
 12. Scroll to the Language parameter. Press the **ENTER** key and use the up and down arrows to change the display language if needed. Press **ENTER** to save the value.
 13. Press the **PROG** key again, close the panel door and go back to the main AQUAVAR display.
 14. Press the down arrow key ▼
The next display will be:
 15. Press the up arrow ▲
to turn on the AQUAVAR II controller.
 16. Open the discharge valve slowly until the pump starts.
Observe the rotation of the pump shaft or motor fan.
 17. Close the discharge valve.
 18. Press the down arrow ▼ to turn off the AQUAVAR II controller.



INVERTER STOP - ON -> START



RUN LIGHT ON

◆ Programming

Installation Procedures continued

19. If the direction of rotation was correct, proceed to the **Programming** section beginning on the following page.
20. If the direction was not correct, **remove all power from the AQUAVARII controller and wait five minutes.**
Open the motor conduit box and exchange any two of the three motor leads. Close the conduit box.
Repeat steps 15 through 18 to check the direction of the motor shaft rotation.

Programming

Programming of the AQUAVARII controller is accomplished by using the three pressure sensitive buttons on the control panel along with the two line LCD display.

The format of the program is a series of menus which can be scrolled through by using the select button. Each screen display is used to provide information about the operation of the system or to change one or more of the operating parameters.

Changes are made by pushing the up or down arrows.

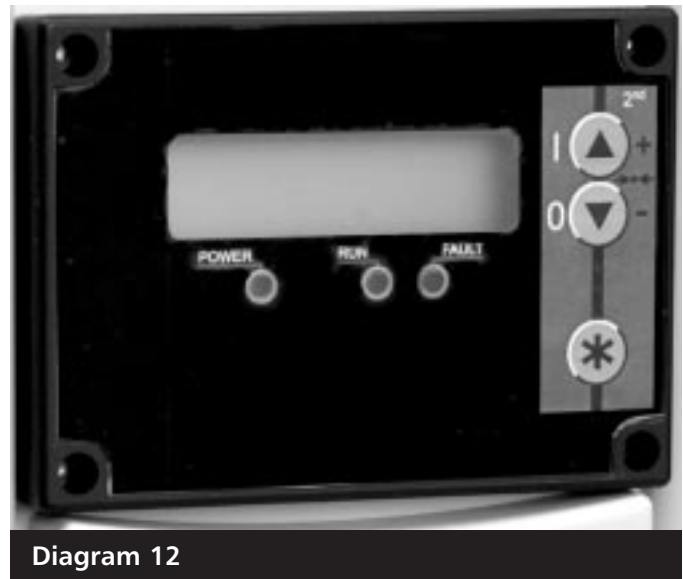

Diagram 12



I. The Main Menu - Setting Single Pump Constant Pressure

Diagram 15 shows the display screens in a flow chart format. Refer to this flow chart for the next 6 steps.

There are ten display screens in the main menu which will allow you to set the required system pressure, save it, and turn the system on. Several of these display screens were already used during the test run. After power has been turned on, the **"Power on"** light should be illuminated and the display should briefly show the software version and date, then show **"No Autostart - disable inverter."**

Programming

Instructions

1. Check Power Light 
2. Press the down arrow  to advance the display to:
3. Press Select  to advance the display to:

Screen

NO AUTOSTART - DISABLE INVERTER

INVERTER STOP - ON->START



REQUIRED VALVE - XXX PSI

Note

If "Inverter Locked" is displayed, the external on/off switch is in the off position or contacts at X1:4 and 5 are not jumpered.

4. Enter the pressure   you want the pump to maintain (constant pressure) for your system.

Press the  until the reading shows the value you want. Use the down arrow to back up if you have gone too far.

For example: if you need a constant pressure of 50 PSI in your system at various demand rates, you would enter 50 as the value by using the  .

5. Autostart setting

Press  to advance the display to:
(This displays the autostart setting.)

Push  to turn the autostart function on.

Screen

REQUIRED VALUE - XXX PSI

50

AUTO START - OFF

AUTO START - ON

If the autostart function is on, the AQUAVARII controller will automatically turn on and resume activity when power is restored after a failure. If autostart is off, the AQUAVARII controller must be manually turned on by the operator after a power failure. Be sure the discharge valve is closed to prevent pump start.

Programming

Note

If you have advanced past a window and want to return to it, press * and ▼ at the same time to back up.

6. Press * to advance the display to:
This display shows the last recorded error or fault encountered by the AQUAVAR controller.
7. Press * to advance the display to:
This in the error which occurred before the last one.
8. Press * to advance the display to:
The error before error 2.
9. Press * to advance the display to:
The error before error 3.
10. Press * to advance the display to:
The error before error 4.
11. Press * to advance the display to:
This is the total amount of run time of the motor. It can be reset using a method described later.
12. **Saving changes**
Press * to advance the display to:
13. Press and hold down **BOTH** arrows  at the same time until the display changes to:
This will allow you to save the changes you have made in the microprocessor memory.
14. After about five seconds the display will automatically return to:

ERROR 1

ERROR 2

ERROR 3

ERROR 4

ERROR 5

TOTAL RUN TIME
0000:00

SAVE ??? ▲+▼

SAVE ??? SAVED

INVERTER STOP - ON->START

Push ▲. The AQUAVAR II controller will begin to automatically maintain system pressure at the point you have selected and the display will show the pressure set point.

Note

If the AQUAVAR II controller is not maintaining the rating you selected, check the sensor adjustment procedures on page 60 or check rotation again.

Programming

AQUAVAR II Controller Program Flow Chart Single Pump Constant Pressure

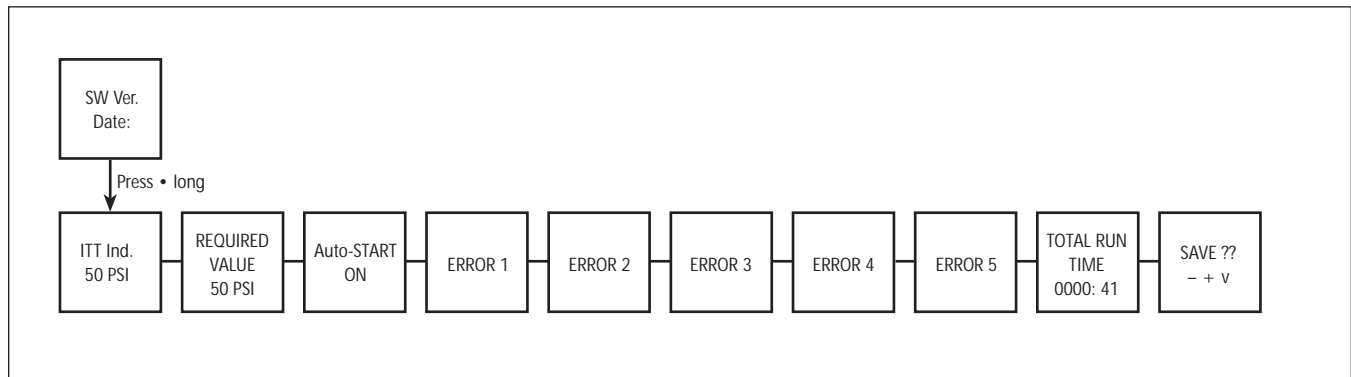

Diagram 13

WARNING

FAILURE TO SAVE SETTINGS AFTER PROGRAMMING RESULTS IN LOSS OF PROGRAM VALUES WHEN POWER IS REMOVED!

II. Single Pump - Pump Protection

The AQUAVAR II controller has the ability to protect the pump by shutting it off in low/no suction or run out conditions.

Note

Low/no suction protection can be managed by the installation of a suction line pressure switch, or float switch for a tank. This switch is connected to the AQUAVAR II controller as described earlier in the Electrical Installation section. The cut off setting for this switch should be the maximum NPSH required by the pump.

To set run out protection:

For steps 1 through 8, refer to the flow chart on page 36.

Instructions

1. Password *The password protection prevents untrained personnel from accidentally changing the base settings.*

- From the main menu, hold down the key for 2-3 seconds until the display changes to:



Screen

PASSWORD 0000

Programming

2. Press the ▲ key until you reach the number 66. You will now be able to access all of the alternate menus for all AQUAVAR controller optional controls.

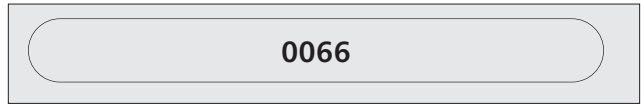

3. Press * to advance the display to the next window:

The jog mode is very useful because it allows you to check on the actual outgoing frequency and system pressure. By pressing either ▲ or ▼ the controller changes to manual, and you can change the frequency to set any constant speed. The Aquavar returns to normal automatic operation when you leave the jog mode window.



4. Continue to briefly touch the * key to scroll past all of the windows and submenus until you reach:

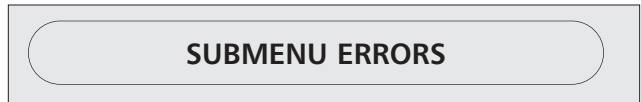

5. Hold the * key down for 2-3 seconds until the display changes to:

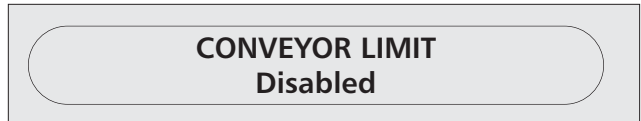

6. Set the minimum pressure the system is allowed to maintain before shutting down. For example, if the set point for the system is 50 PSI, and the operator will allow anything above 41 PSI, then the conveyor limit would be set at 40 PSI. This function can also be turned off by pressing ▼ until "disabled" is shown.

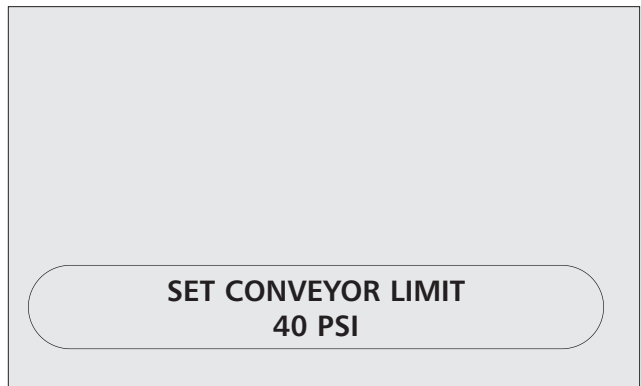

To set timed protection:

7. Delay Time *Enter the amount of time that the pump is allowed to run at maximum frequency after pressure begins to drop below the conveyor limit. This should never occur if the system has been properly sized and there are no leaks in the system. Note: This delay time is also applied to low suction pressure switch, on terminal X1, 6 and 7.*

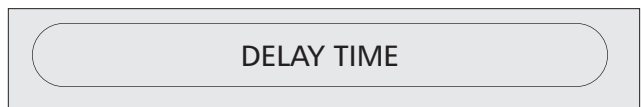

Programming

Press the ▼▲ to enter the number of seconds. The pump will run after pressure begins to drop at pump run out or a suction switch activates.

15 SEC

8. **Error Reset** Turning this control on will enable the AQUAVARII controller to retry its operation five times when a fault condition occurs. Turning the control to "off" means that the AQUAVARII controller will shut down the first time a fault occurs. Select the mode you want by pushing the up or down arrow key.

Note

"Fatal" errors will always shut down the system the first time.

- Press * to advance the display to:

ERROR RESET

Press ▲ to set the time between attempted restarts or ▼ to disable this function

9. Clear error. The error memory can be deleted by entering a password supplied by your distributor.

CLEAR ERRORS
0000

Returning to normal operation:

10. Hold down the * key for 2-3 seconds until the display changes to:

Screen

SUBMENU ERRORS

11. Briefly touch * key to scroll until you reach the display:

SAVE ??? ▲ + ▼

12. Press both ▲▼ at the same time until the display changes to:

SAVE ??? SAVED

After a moment, the screen will automatically return to the main menu start position.

Programming - Single Pump Protection

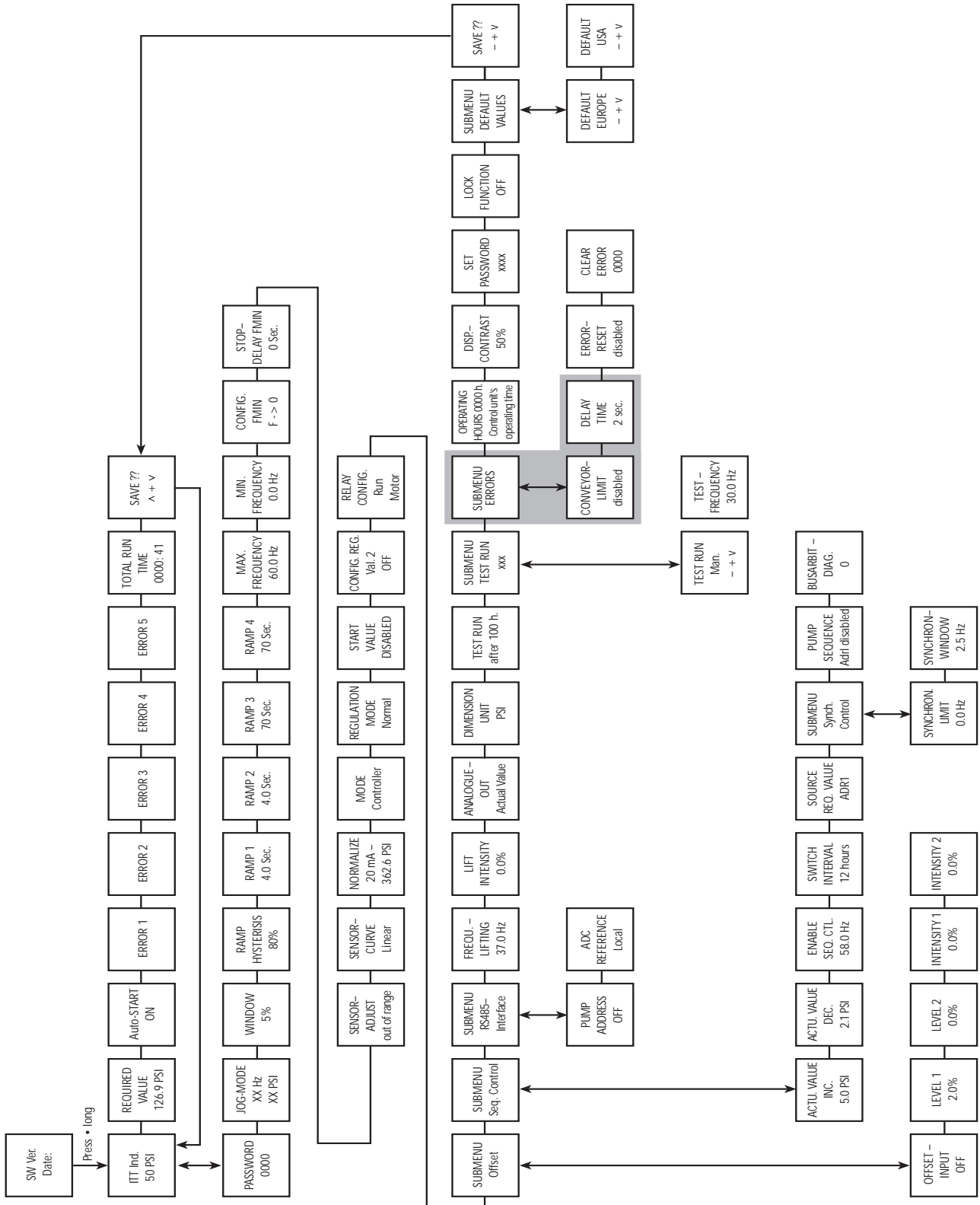

Programming

III. Single Pump - System Curve Compensation

The AQUAVAR controller can automatically compensate for system friction losses due to increased flow. Tables are available in most pump catalogs indicating the amount of friction loss that can be expected in various sizes of pipe at different flow rates. Use these tables to **determine the friction loss for the pipe size you are using at your maximum flow rate.**

Diagram 15 shows a typical system curve. The system pressure set point is shown at shut off and the pressure increase is shown for increasing flow.

Calculate the pressure increase required to overcome friction loss at maximum flow as a percent of the set point.

For example, if your required system pressure is 30 PSI, and it takes an additional 3 PSI for friction loss at maximum flow, the percent increase is 10%.

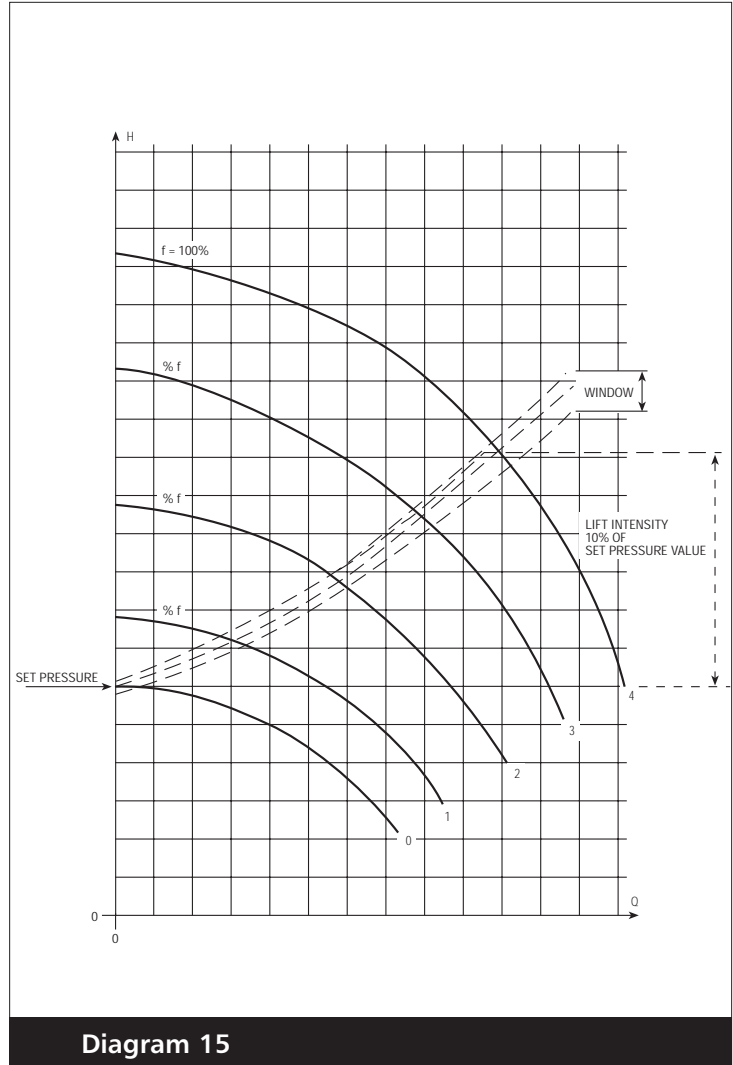



Diagram 15

Programming

Entering compensation values:

For steps 1 through 4, refer to the flow chart.

Instructions

1. From the main menu, hold down the  key for 2-3 seconds until the display changes to:

- Enter **66** by pressing the 

Screen

PASSWORD 0000



0066

2. **Freq.- Lifting 30.0 hz** *This indicates the speed (flow rate) at which you want the pressure compensation to begin. On a 60 hz system, there is virtually no flow below 40 hz. Set this frequency with the up arrow. On a 50 hz system, the normal starting point would be 30 hz.*

- Use the  key to scroll through the menu screens until you reach:
Change if required.

FREQ - LIFTING 40.0 HZ

3. Use the  key to move to the next screen:

- Use the   to enter the percentage pressure increase **calculated on page 37**.

LIFT - INTENS. 0.0%

LIFT - INTENS. 3.0%

Increase values are recommended from 0 to 20%. If your friction loss increase is above 20% of your set pressure, please contact the AQUAVAR distributor or factory for application assistance. 0-99.9% actual.

4. Save the new settings.

- Use the  key to scroll to the screen
- Press both the  arrows until the display indicates the save process is complete.

SAVE ???  + 

SAVE ??? **SAVED**

The screen will automatically return to the main menu.

Programming

Circulator applications

On circulator pumps, the system curve can be automatically tracked through the use of a differential pressure transducer. This pressure transducer reads the outgoing discharge pressure and the incoming return pressure and compensates for differences in pressure as demand and speed increase. Programming is the same as just covered for the single transducer version. Data on the differential pressure transducer can be found in Appendix A.

IV. Single Pump Constant Flow

A single pump AQUAVAR controller system can also be set to maintain a constant flow by changing motor speed to create more or less pressure when demand changes. The pump should be selected so that the flow rate required is approximately in the middle of the pump curve and the maximum pressure is within the performance of the pump at maximum speed. In general, pumps are not designed to be piped in series (discharge to suction) due to maximum working pressure limitations. Select a single pump which meets system requirements through either higher staging or larger impeller diameters.

An orifice plate with differential transducer or a flow transducer can be used for constant flow applications. Follow the instructions provided with the orifice/transducer or flow transducer assembly for installation procedures and electrical connections.

Instructions

In flow applications, you will want to change the sensor curve from linear or to quadratic and the units from PSI to %, when using to orifice/transducer assembly. To do this, hold down the

***** key at the main menu until screen:

1. Enter the number **66**.
2. Briefly press the ***** key to scroll through the displays until screen:
3. Use the **▲** to change to Quadratic. **Note:** If you are using a flow sensor rather than an orifice plate, leave the sensor curve at linear.
4. Briefly press the ***** key to scroll through the displays until screen:

Screen

PASSWORD 0000

0066

SENSOR CURVE

QUADRATIC

DIMENSION UNIT PSI

Programming

Single Pump Constant Flow continued

5. Use the ▲ to change the units to GPM if you are using a flow sensor or % if you are using the orifice plate.



6. Hold down the * key until the screen:

7. Hold down the * key until the screen:

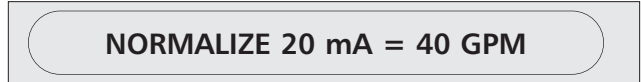

8. Enter either 37 psi for orifice plate application or the maximum flow range of your flow sensor in gpm.

9. Hold down the ▲▼ at the same time until

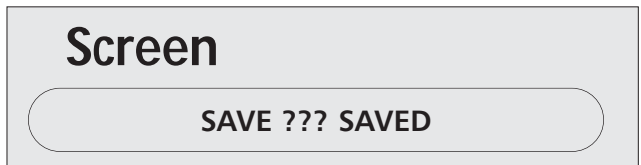

The display will automatically return to the main menu.

10. Advance to the screen:



11. Use either ▲▼ to enter the flow you want to maintain on the AQUAVAR II controller (see example). For orifice plate applications, use the table below to set the required %.



Select orifice size from the following chart. Select the orifice by the maximum flow of the pump.

Orifice	Nominal Pipe Size	Flow Range GPM
1	1"	12-35
2	1"	18-52
3	1 1/2"	20-62
4	1 1/2"	32-90
5	2 1/2"	35-105







Orifice	Nominal Pipe Size	Flow Range GPM
6	2 1/2"	52-160
7	3	52-160
8	3	70-210
9	3	120-350

Based on the maximum flow shown for the orifice selected, calculate the percent of maximum flow you want to maintain. For example, to maintain a flow of 20 GPM with a #1 orifice, select 57% (20 ÷ 35).

Programming

V. Single Pump - Level Control Applications

For drainage applications using a surface pump, the transducer is typically needed to measure pressure on the suction line. As the catch basin or tank empties, the pressure will decrease, and the pump needs to slow down and eventually stop. This is the opposite way the AQUAVAR II controller would usually respond. To change to suction side measurement:

1. On the main menu, enter the PSI value of the liquid at the LOWEST level you want to maintain. For example, you may want to leave 3-4 feet of water in a tank which is equal to 2-3 PSI.
2. From the main menu, hold down the  key for 2-3 seconds until the screen changes to:
 - Enter 66 by pressing the  key.
3. Use the  key to scroll to:
 - Use the  key to change to inverse.
4. Briefly press the  key until the screen:
5. Hold down the  at the same time until:
The display will automatically return to the main menu.

In operation, the pump will start wherever the suction side pressure is above the set point and slow down and stop when the suction pressure comes down to the set point and stays there.

Screen

REQUIRED VALUE - PSI

PASSWORD 2000

0066

REGULATION MODE - NORMAL

REGULATION MODE - INVERSE

SAVE ??? +

SAVE ??? SAVED

Note

For discharge level control, the programming operation is the same as a constant discharge pressure system.

Programming

VI. Single Pump - Submersible Applications and Minimum Frequency

It is possible to use the wall mounted version of the AQUAVAR II controller with a submersible pump. *Never attempt to mount an AQUAVAR II controller on the pump itself in these applications since the AQUAVAR II controller is not designed to be submerged. The standard distance allowed between the pump and the AQUAVAR II controller is up to 60 feet. If you need a longer connection, be sure to contact your distributor for a drive applied filter or load reactor.

The submersible pump will often use motor service factor and will overload the AQUAVAR II controller at maximum speed. To avoid this, select an AQUAVAR II controller based on the service factor amp rating of the motor and the maximum amps allowed by the AQUAVAR II. If you have questions about the requirements of the submersible pump and which AQUAVAR II controller to use, please contact the AQUAVAR II controller distributor or factory applications Goulds Pumps.

The submersible pump can be set for either constant pressure or level control applications as described in programming section I and section V. Normally, the constant pressure application would use well pumps or turbines with a steady source of water. Drainage applications would normally use a sump, effluent or sewage pump.

Minimum Frequency

Many submersible well pumps have a required minimum frequency to keep motor bearings lubricated. To avoid running the motor at lower frequencies, you can program in a minimum frequency. For most Franklin submersible motors the minimum is 30 Hz, so a setting of 35 Hz is good.

NOTE

End suction centrifugal pumps may also be used in level control systems for draining or filling. Multiple pumps end suction or submersible systems may also be used in level control.

Programming

At the status window, hold the ***** key until you reach the password screen. Enter the password.

PASSWORD 0066

Use the ***** key to advance to:

MINIMUM FREQUENCY
0 Hz

Use the **▲** and **▼** to change to the desired minimum frequency (Example 35 Hz).

MINIMUM FREQUENCY
35 Hz

Use the ***** key to advance to:

CONFIG. FMIN
F -> FMIN

Use the **▲** and **▼** arrow keys to change to:
This allows the AQUAVARII to go down to the selected minimum frequency but not below it.

CONFIG. FMIN
F => 0

Note

In the setting $f \rightarrow F_{min}$, the AQUAVARII will only run between minimum frequency and maximum frequency. Automatic shut off is not possible, but manual shut off is possible with external on/off connected at X1/4 and X1/5.

Use the ***** key to advance to:

STOP - DELAY FMIN
OS

Use the **▲** and **▼** keys to enter the number of seconds the AQUAVARII will run at minimum speed before it shuts off when there is no demand.

STOP - DELAY FMIN
10

Advance to the same window and save all settings.

SAVE ??? **▲+▼**

Programming

VII. Setting A Second Fixed Required Value

The AQUAVAR II controller can also be used in applications where the required value changes. As an example, a single pump system might be used to supply both water supply and irrigation needs on a farm. When the irrigation system is used, the pressure which needs to be maintained is higher than the pressure for normal water supply. The AQUAVAR II gives you the ability to program in this higher set point and to automatically change to it when the irrigation system turns on, and change back when it turns off.

Electrical

Wiring for the switch to change between one set point and the other is shown below. This could be a normal switch or a timer for automatic operation. Wire the switch to X1-14 and X1-10 (ground). When the switch is open, set point 1 is used. Closing the switch activates set point 2.

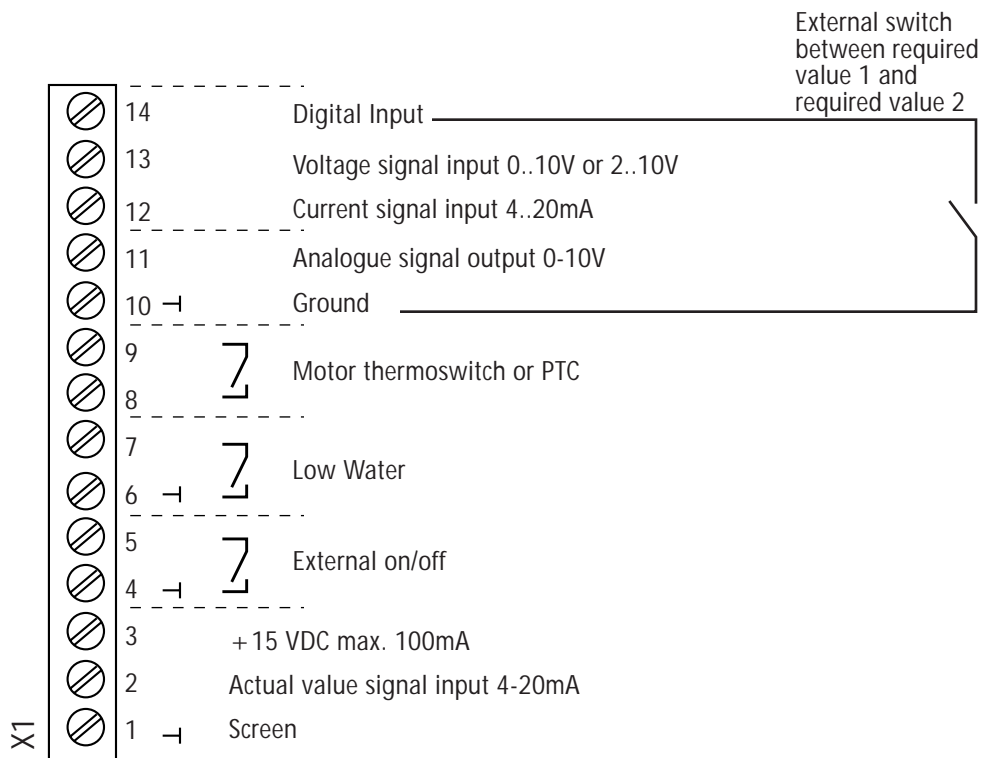

*Refer to Appendix B for explanation of terminals.

Programming

Enter the submenu by holding the  key.

ITT INDUSTRIES
20 PSI

Enter the password and press the  key.

PASSWORD
0066

Press the  key until you see the screen:

CONFIG. 2ND REQUIRED VALUE
OFF

Use the  and  arrows to change the selection to:

CONFIG. 2ND REQUIRED VALUE
INT

Note

The other possibilities (Ext. ADC-1, Ext ADC-U 0-10V, Ext ADC-V 2-10V) involve variable second values controlled by a second sensor. These are discussed in the next section.

Advance the display with the  key to:

SUBMENU
SEQUENCE CONTROL

Hold the  key to enter the submenu.



Press the  key to advance to:

SOURCE REQUIRED VALUE
OFF

Use the arrow keys to change to:

SOURCE REQUIRED VALUE
ADR1

Hold the  key to leave the submenu then advance to:

SAVE ??? +

Press both buttons until the display changes to:

SAVE ??? SAVED

Press the  key to advance to:

REQUIRED VALUE 1
XXX PSI

Use the  and  arrows to set the first required value.

Close the switch connected to X1-10 and X1-14 to activate the second set point. The display changes to:

INT REQUIRED VALUE 2 XXX PSI

Use the  and  arrows to set the second required value.

Advance to the Save window and save all settings.

SAVE ??? SAVED

Two required values are now stored in memory. The active required value is determined by the switch on X1/10 - X1/14. As noted earlier, this can be a manual or automatic (timer controlled) switch.

Programming

VIII. Variable Second Required Value

In this section, we will cover the set up and programming of the AQUAVAR II for a second sensor input. This sensor can be either a 4-20mA or 0/2-10V device such as a pressure transducer, flow transducer, heat sensor, etc. When connected to the AQUAVAR II, the output of this second sensor becomes the new set point. As input from the second sensor changes, the set point will also change.

Example: If the second sensor was a 150 psi 4-20mA pressure transducer and the input to the AQUAVAR was 10mA, the set point would become 62 psi. If the input dropped to 8mA, the set point would go to 94 psi. Keep in mind that this change only offsets the set point. Motor speed continues to be varied by the primary transducer reading of demand change. This function could be used for chlorine or fertilizer injection where a flow sensor in the main pipe would track system demand and adjust the pump flow set point to keep the mix percentage the same.

Electrical

Connect the second sensor as shown to X1/10 and either X1/12 for 4-20mA or X1/13 for 0/2-10V.

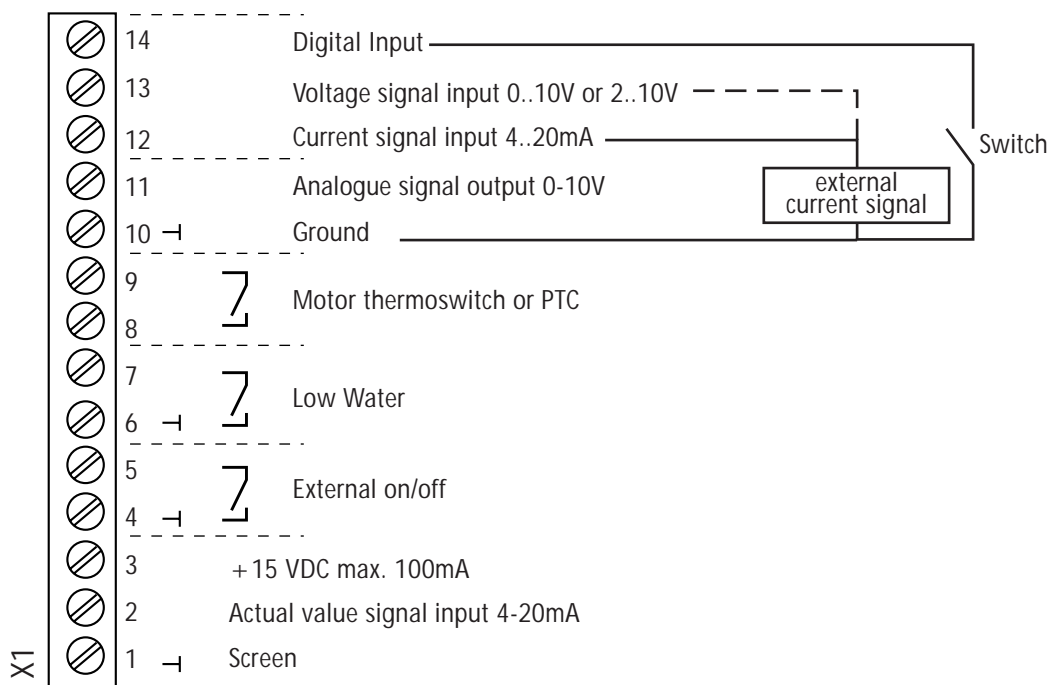

Programming

Enter the submenu by holding the  key.



ITT INDUSTRIES
20 PSI

Enter the password and press the  key.

PASSWORD
0066

Press the  key until you see the screen:

CONFIG. 2ND REQUIRED VALUE
OFF

Use the  and  arrows to change the selection to:
EXT ADC-1 for 4-20mA input
EXT ADC-U 0-10V for 0-10V input
EXT ADC-U 2-10V for 2-10V input

CONFIG. 2ND REQUIRED VALUE
EXT ADC-1

Advance the display with the  key to:

SUBMENU
SEQUENCE CONTROL

Hold the  key to advance to:

SOURCE REQUIRED VALUE
OFF

Use the arrow keys to change to:

SOURCE REQUIRED VALUE
ADR1

Hold the  key to leave the submenu then advance to:



SAVE ??? +

Press both buttons until the display change to:

SAVE ??? SAVED

Press the  key to advance to:

REQUIRED VALUE 1
XXX PSI

Use the  and  arrows to set the first required value.

Close the switch connected to X1/10 and X1/14 to activate the second set point. The display changes to:

REQUIRED VALUE 2
EXT ADC-1 XXX PSI

Note

This display is now a read only window. The actual set point is coming from the external signal.

Offsets

It is also possible to use second sensor input as an offset for the primary required value. An example would be locating the second sensor in a supply tank or well and setting an offset so that when the water level got too low, the pump discharge pressure setting would be reduced until the tank or well had recovered.

Another example would be the use of both a pressure sensor and flow sensor in the discharge line so that if the flow became too high for the pump, the offset could reduce the discharge pressure set point to keep the pump from cavitation.

Programming

To implement the offset function,

Enter the submenu by holding the  key.

ITT INDUSTRIES
20 PSI

Enter the password and press the  key.

PASSWORD
0066

Press the  key until you see the screen:

SUBMENU
OFFSET

Enter the submenu by holding down the  key.

OFFSET INPUT
OFF

Use the  and  arrows to select the source of the second value:

OFFSET INPUT
EXT ADC-1

- EXT ADC-1 for 4-20mA input
- EXT ADC-U 0-10V 0-10V input
- EXT ADC-U 2-10V 2-10V input

Refer to the following page to determine the offset variables and intensities to use for your application.

Example for Offset:

Sensor range: 20mA \triangleq 150 PSI

Required value: 75 PSI

Level 1: 20% of the 2nd additional input **Level 2:** 80% of the 2nd additional input

Intensity 1: -10% \triangleq -15 PSI (refer to the required value)

Intensity 2: -20% \triangleq -30 PSI (refer to the required value)

Programming

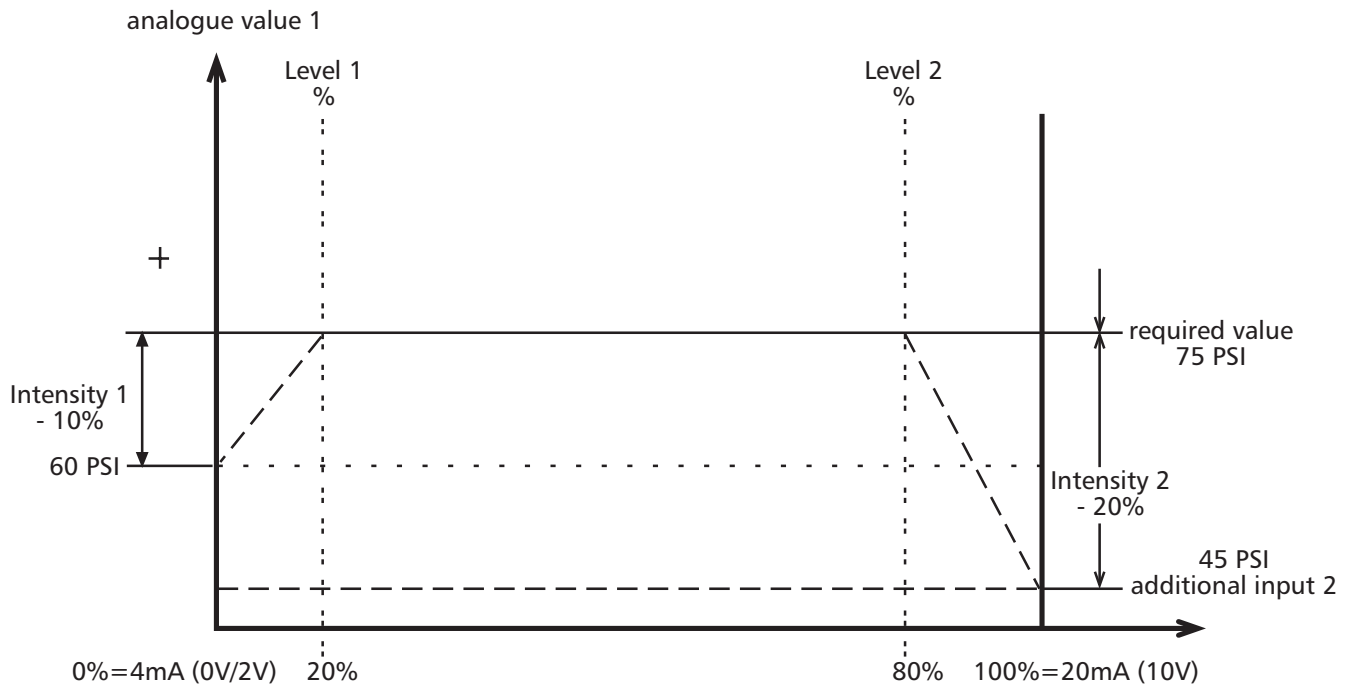

At *Level 1* and *Level 2*, you enter the required value in percent from the *Second Additional* input (20%) and (80%).

Intensity one and two depend on the *Sensor range* of the external value signal. The *Intensity 1* that you have entered is valid until you reach *Level 1*, after reaching *Level 1* the *Required Value* has no offset.

The *Required Value* is valid until you reach *Level 2*. After reaching *Level 2*, the new value, depending on the *Intensity 2*, is valid.

Note that for most applications only one level and one intensity would be needed.

Press the ***** key to advance to:

LEVEL 1
XX.X%

Use the **▲** and **▼** arrow keys to enter the % of the additional input range where the first offset to the required value will occur. The chart on the previous page uses 20% as an example.

LEVEL 1
20.0%

Press the ***** key to advance to:

LEVEL 2
XX.X%

Use the **▲** and **▼** arrow keys to enter the % of the additional input range where the second offset to the required value will occur (if needed) The chart on the previous page uses 80% as an example.

LEVEL 2
80.0%

Programming

Press ***** key to advance to:

INTENSITY 1
+XX.X%

Use the ▲ and ▼ arrow keys to enter the % of the required value you want to increase or decrease when the second sensor input is below Level 1. The

INTENSITY 1
-10.0%

chart on the previous page uses -10% as an example. This represents an application where the second sensor is in a well or tank. When the pressure reading or the second sensor drops below an acceptable minimum, the discharge pressure set point automatically drops by 10% to give the tank or well time to recover. As soon as the pressure in the well reaches the minimum again, the set point returns to normal.

Press the ***** key to advance to:

INTENSITY 2
+XX.X%

Use the ▲ and ▼ arrow keys to enter the % of required value you want to increase or decrease when the second sensor input is above level 2. The

INTENSITY 2
-20.0%

chart on the previous page was -20% as an example. This represents an application where the second sensor is a flow transducer in the discharge line. When the flow reading on this second sensor goes higher than an acceptable maximum, the discharge pressure set point automatically drops by 20% until flow demand is reduced. As soon as flow is back below the maximum again, the set point returns to normal.

Hold the ***** key to get out of the submenu.

SUBMENU
OFFSET

Press the ***** key to advance to:

SAVE ??? ▲+▼

Press both arrows to save the settings.

SAVE ??? SAVED

Programming

IX. Multiple Pump Constant Pressure and System Curve Compensation

When two, three, or four AQUAVAR II controller controlled pumps are connected in a system, they can be programmed to work together to maintain system pressure up to the maximum flow rate of all pumps combined. As the first pump reaches its maximum speed and flow, the second pump will automatically turn on (and so on). In addition, the sequence of the pump that will run first (lead pump) can be automatically varied to reduce premature wear on any one pump in the system.

1. Refer to the section **The Main Menu - Setting One Pump Constant Pressure**. Follow steps 1 through 6, then continue with step 2 below.

Instructions

2. From the main menu, hold down on the ***** key for 2-3 seconds until the display changes to:
 - Use **▲** to enter the number:
3. **Mode: Multicontroller** *This setting allows the AQUAVAR II controller units to communicate with each other in a multi-pump system.*
 - Use the ***** key to scroll through the screens to reach:
 - Use the **▲▼** to change the setting to:

Screen

PASSWORD 0000

0066

MODE CONTROLLER

MODE: MULTICONTROLLER

Note

Other possibilities are Synchronous Controller described later in this section and Actuator which shuts off the internal controller and allows the AQUAVAR II to function as a standard VFD. This can be from external input (actuator) or manual control (actuator local). This is described further in operator custom features and displays.

4. Advance to the next screen:

SUBMENU SEQ CONTROL

Programming

Multiple Pump Constant Pressure... continued

Generally, a slight pressure drop is allowed on the first pump before the next is started. This allows for brief system fluctuations without pump cycling. Once the next pump starts, however, you will want the system to resume its normal set pressure.

5. To do this, enter the amount of pressure drop you will allow before the next pump starts.

Diagram 16 shows the pressure drop and increase.

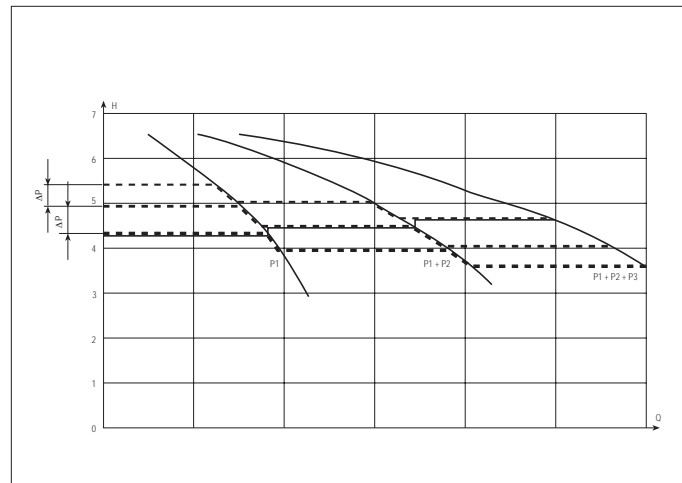

Diagram 17

6. To increase the pressure even more to compensate for system losses at higher flow, enter the total of the system drop allowed before next pump starts and the increased pressure desired.

For example, if the pressure drop allowed is 5 PSI before the next pumps starts, and the increased pressure needed to compensate for system losses is 3 PSI, you would enter 5 + 3, or 8 PSI to compensate for both system pressure drop and compensation requirements.

*Examples: Value Increase = Value Decrease —> Pressure is constant
Value Increase > Value Decrease —> Pressure increases with each additional pump
Value Increase < Value Decrease —> Pressure decreases with each additional pump*

Note

This value is cumulative. An extra 3 PSI will be added to the total system pressure with each additional pump which turns on. For example, if the initial system pressure was 50 PSI, pump two would create 53 PSI, pump three would create 56 PSI, and pump four would create 59 PSI system pressure.

7. Pressure Incr. 000 psi *This setting tells the AQUAVAR controller how much to increase the pressure setting when the second pump turns on.*

- Hold down the ***** for 2-3 seconds until the display changes to:

ACTUAL VALUE INC. 000 PSI

Programming

Multiple Pump Constant Pressure... continued

8. Enter the value required.

- Press  to advance to the next screen:
- Enter the **PSI drop** before the next pump starts. Use this value for each pump in the AQUAVAR controller system.

Screen

ACTUAL VALUE INC. 0003 PSI

ACTUAL VALUE DEC. 000 PSI

ACTUAL VALUE DEC. 0002 PSI

9. Enable Seq. Ctl. 60.0 hz *This tells the next pump when the preceding pump has reached its maximum speed.*

- Press  to advance to the next screen:

Screen



ENABLE SEQ. CTL. 60.0 HZ.

In most North American applications, this would be set for 58-60 hz. If you are using a 50 hz system, reset the display for 50 hz.

Note

The next pump will not start until both the system pressure drop and maximum first pump speed have been reached. If Enable Sequence Control is set higher than the maximum frequency, the next pump will not start.

10. **Switch Interval** *This allows you to set the amount of time before the “lead pump” switches over to another pump in the system. This means that the first pump to turn on when the system starts up will change when the switch interval time is reached. A manual change over is also possible by using the  in the first main menu display.*

- Press  to advance to the next screen:
- Use the   to set the time desired.
(If set over 100 hours, the function is disabled.)

SWITCH INTERVAL

Programming

Multiple Pump Constant Pressure... continued

Source Required Value

The next screen refers to the use of a second input signal for changing the required value. This was discussed in Section VIII.

If a second sensor or switch is used, you must tell the AQUAVAR II which pump has the connection. Use the ▲ and ▼ keys to select. ADR1, ADR2, ADR3 or ADR4. If you are not using a second sensor, leave this set to "off" or "disabled".

SOURCE REQUIRED VALUE
ADR1

Follow the other steps in Section VIII for using a second sensor with multiple pumps.

11. Synchronous Control: If you choose synchronous control, the second pump (and 3 or 4) will all try to regulate the pressure together by running at the same frequency (speed). In order to get the second pump to shut off, you need to set a minimum frequency.

- To choose synchronous control hold * to enter the submenu.
- When synchronous limit appears use ▲ to set the frequency for pump #2 to shut off. For 60 Hz pumps, this would normally be 50 hz.
- If pumps 3 and 4 are used, advance to the synchronous window with *
- The window can be set between 0-10 Hz. This number will be added to the synchronous limit. For example, if the synchronous window is set at 5 hz, pump four will turn off when all pumps go below 50 hz, and pump three will turn off when all pumps go below 45 hz.

SUBMENU SYNCH. CONTROL

SYNCHRON LIMIT - DISABLED

SYNCHRON LIMIT - 50 HZ

SYNCHRON WINDOW - 0 HZ

SYNCHRON WINDOW - 5 HZ

Note

The synchronous option can only be used if all pumps are the same.

Programming

Multiple Pump Constant Pressure... continued



12. Pump Address *In this section you will give the pump an address number. Generally, the first pump programmed will be number 1, the second will be number 2, and so on. The purpose of this is to help the AQUAVARII controller sequence the start and stop activity of the pumps in the system including the selection of lead and lag pumps.*

- Hold the  for 2 seconds to return to:

SUBMENU SEQ. CONTROL

- Press  again briefly to advance to:

SUBMENU RS485 INTERFACE

- Press  again for 2 seconds to display:
- Use the  to select the address number. (1, 2, 3 or 4)

PUMP ADDRESS OFF

Screen

13. Hold the  for 2 seconds to return to:

SUBMENU RS485 INTERFACE

- Press  briefly to advance to:

FREQ. LIFTING

- Press  again to advance to:



LIFT INTENSITY 0%

- Set at 0% with 

SAVE ??? +

- Hold the  for 2 seconds to return to the Main Menu.

- At the Main Menu, advance to the screen:

SAVE ??? +

- Press  at the same time until the display changes to:

SAVE ??? SAVED

14. Repeat steps 1 through 12 for each pump in the system. Use a different address number for each pump.

Programming- Multiple Pump Constant Pressure

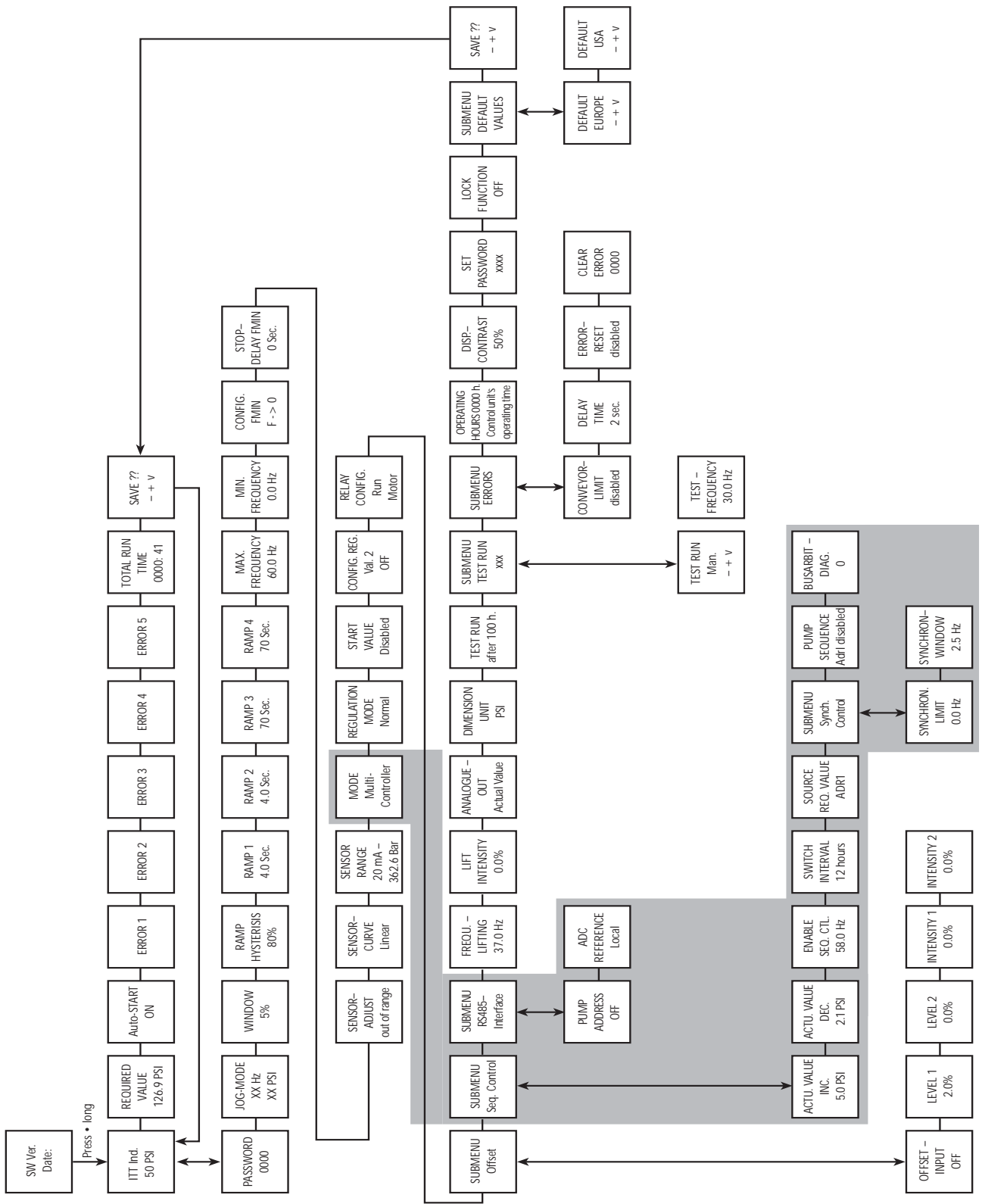

Programming

X. Multiple Pump - Pump Protection

The AQUAVAR controller can protect the pump by shutting it off in low/no suction or run out conditions.

Note

Low/no suction protection depends on the installation of a suction line pressure switch or float switch for a tank. This switch is connected to the AQUAVAR II controller as described earlier in the electrical installation section. The cut out setting for a suction pressure switch should be greater than the maximum NPSH required by the pump.

To set low/no flow and run out protection:

Instructions

1. Press the ***** key for 2 seconds and advance to the:

- Use **▲** to enter **66**.

- Use the ***** key to scroll to:

*Conveyor limit is default "disabled".
Use **▲** and **▼** to set a low discharge pressure shut off value.

2. Press the ***** key for 2 seconds to display: Set the minimum pressure the system is allowed to maintain before shutting down. For example, if the set point for the system is 60 PSI and the operator will allow anything above 55 PSI, then the conveyor limit would be set at 54 PSI.

- Press ***** again briefly to advance to:

- Enter the amount of time the pump is allowed to run after the suction pressure switch or float switch has activated. This is also used to set the amount of time the pump can run at maximum frequency after the pressure drops below the conveyor limit.

Screen

PASSWORD 0000

0066

SUBMENU ERRORS

CONVEYOR LIMIT - 40 PSI

DELAY TIME
0.0 SEC

DELAY TIME
2.0 SEC

Note



When using this feature, each pump in the system can have its own switch or a junction box must be used for multiple pump operation with one switch, in series.

Programming

Multiple Pump Pump Protection... continued

Instructions

3. Error Reset *Turning this control on will enable the AQUAVARII controller to retry its operation five times when a fault condition occurs. Turning the control to "off" means that the AQUAVARII controller will shut down the first time a fault occurs.*

- Press  to advance the display to:
- Use the   to select the mode you want.



Screen

ERROR RESET

Note

"Fatal" errors will always shut down the system the first time.

Returning to normal operation:

4. Hold down the  key for 2-3 seconds until the display changes to:
 - Scroll past the next few screens (briefly touch the  key) until you reach:
5. Save the new settings by pressing the  at the same time until the display changes to:

SUBMENU ERRORS

SAVE ???  + 

SAVE ??? SAVED

After a moment, the screen will automatically return to the main menu start position.

6. *Repeat steps 1 through 5 above for each of the other pumps in the system which have suction switches or float switches.*

Operator Custom Features and Displays

Operator Custom Features and Displays

Refer to the overall Program Flow Chart for the location of the following operator custom features.

To access a particular feature:

- Enter the password (66) at the Main Menu.
 - Scroll to the selected feature by using the “★” key.
- Other features have already been discussed in the application set-up instructions described earlier.

Note

Custom features are pre-programmed to default settings. These settings are the same for all horsepower sizes and may require adjustments to meet the particular pump system and horsepower requirements.

Jog-Mode

This display shows the actual frequency, in Hz, the pump is running and the signal being read by the pump’s transducer. The frequency (speed) can also be manually changed by using the up or down arrow keys. When leaving the Jog Mode, the pump will automatically return to normal operating speed unless you have set 0.0 Hz for the frequency setting (this sets the AQUAVAR II controller to “off”).

Window

The AQUAVAR II controller regulates motor speed in very small increments, allowing the pressure to rise and fall within a range around the set point. This range is called the “window.” The size of this window can be set as a percentage of the set pressure.

For example, if the set pressure is 100 PSI and the window is set at 10%, the swing in pressure would be 10 PSI (5 PSI above the set pressure and 5 PSI below the set pressure) during operation. This large a swing would probably become noticeable as motor cycling or surging. This setting should be adjusted according to the required value. Lower required values should use about 10% and higher required values should use about 5%. Adjustments may be needed for different systems.

Ramp Hysteresis

This setting tells the AQUAVAR II controller what portion of the operating window should be set aside for electrical fluctuations in the system (Hysteresis). Part of this built-in inaccuracy is due to the pressure transducer and part is due to the inverter drive. Typically, this would be set at 50%. In a 4 PSI window, 2 PSI would be the expected hysteresis error. This is also the point at which the AQUAVAR II changes over to the long slow ramps.

Ramp Settings

The next four displays relate to the time it takes for the AQUAVAR II controller to speed up and slow down the motor when pressure or flow requirements change. **In normal operation, these should not be changed. Please carefully read the descriptions for the ramp speeds.**

Operator Custom Features and Displays

Ramp 1

This ramp is the fast run up time used when the pump first comes on and is trying to reach the set point. The normal set point for this ramp is 4 seconds for the horse power range 2 through 15 hp. For versions with higher horsepowers, 20 hp and above, the setting should be 10 seconds minimum. A setting which is too fast may overload the inverter. A setting which is too slow tends to cause uneven outgoing pressure (pressure drops).

Ramp 2

This ramp is the fast run down time used when the pump is shutting down after demand has ended. The normal set point for this ramp is 4 seconds for the horse power range 2 through 15 hp. For versions with higher horsepowers, 20 hp and above, the setting should be 10 seconds minimum. A setting which is too fast leads to pump oscillation or hunting. A setting which is too slow tends to generate overpressure. **Note: air in the pump system can cause a condition which looks like hunting. Please be sure all air is purged from the system before trying to change ramp 2.**

Ramp 3

This ramp is the slow run up time used when the pump is operating within its set point window as described above. The normal setting is 50 seconds. A setting which is too slow may cause the outgoing pressure to drop when demand varies. A setting which is too fast may lead to over oscillation and inverter overload.

Ramp 4

This ramp is the slow run down time used when the pump is operating within its set point window. The normal setting is 50 seconds. A setting which is too slow leads to oscillation. A setting which is too fast delays motor shut down after demand is over.

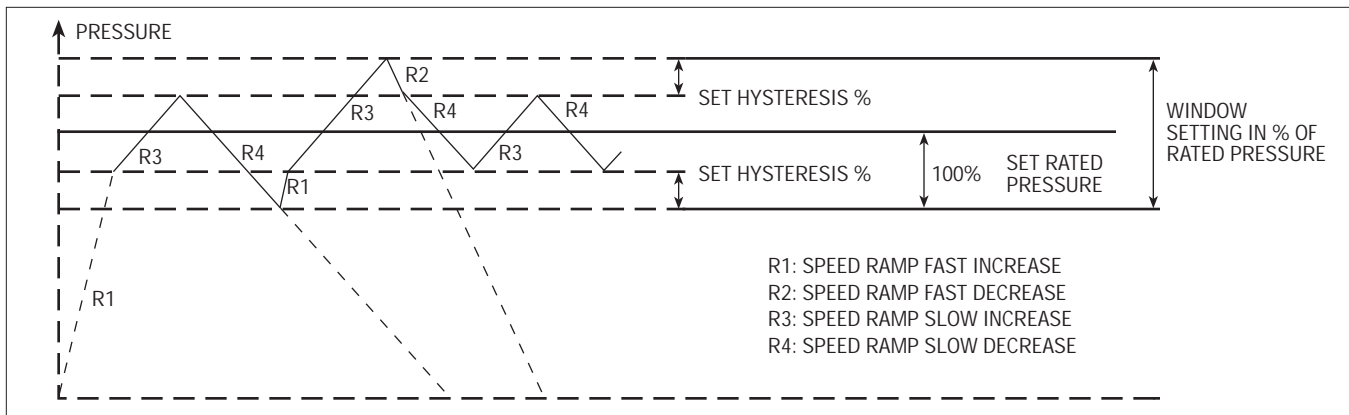

Diagram 19

Maximum Frequency

This setting should match the requirements of the motor being used. If the motor being used is a 60 Hz motor, the setting should be 60 Hz. If the motor is 50 Hz, change this setting to 50 Hz.

Note

It is possible to set this frequency up to 70 Hz. This is not recommended for standard pumps. A 10% increase in frequency causes 33% more power draw. Pump and motor warranty will be void if operated above 60 Hz. Check with pump and motor manufacturer first!

Operator Custom Features and Displays

Minimum Frequency

Settings between 0 and 50 Hz are possible. When a minimum frequency is set, the AQUAVAR II will not run the pump below this speed. See the section on submersible pumps, page 44.

Config. F Min

This setting allows you to configure a minimum frequency in one of two ways. If you select “f->0”, the inverter will go down to the minimum frequency and then continue running at that level for the delay time (see next features). If there is no demand, the inverter will shut off. It will not ramp down through lower frequencies.

If the selection is “f->f min” the inverter will slow to the minimum frequency but will not stop unless there is a fault or an external control is connected to terminals X1/4 and X1/5. **Caution: There is a possibility of pump overheating without automatic shut off.**

Stop-Delay F Min

This is the delay time in use if “F->0” is set above. If a minimum frequency is set and F->0, then the AQUAVAR will run down to minimum frequency, for the delay time and then shut down. Delay time is set in seconds.

Sensor Adjustment

The AQUAVAR II controller can automatically calibrate the sensor (transducer or flow meter). Close all gate valves around the sensor, remove transducer from piping, turn off the pump, and relieve static pressure so that the sensor reads zero pressure or flow. Press the up and down arrows at the same time until “**adjusted**” is displayed.

Note

If “Out of Range” is displayed, the system is still under pressure and the transducer cannot be calibrated.

The second sensor adjustment, “**Sensor Curve**,” allows control of linear and quadratic sensors. Use the linear setting for pressure, differential pressure, level, temperature and flow transmitters. Use the quadratic setting only for constant flow control with orifice plates and differential pressure transmitters.

The third sensor adjustment, “**Normalize or Sensor Range**,” allows the maximum pressure or flow rating to be set for the sensor being used. Refer to the specification sheet for the sensor you are using to determine the maximum rating at 20mA. Use the up or down arrow to advance to the correct setting. The standard transducer supplied with the AQUAVAR II controller is 25 bar (362.6 PSI).

Mode

This setting is used to tell the AQUAVAR II controller the type of input which will be used to control the system.

Controller - Used for a single AQUAVAR II controlled pump

Multicontroller - Used where several AQUAVAR II pumps are connected via RS485

Operator Custom Features and Displays

Synchronous Controller - Used for multipump systems where all pumps will run at the same frequency. (Used for more efficient pump operation.)

Actuator - Used if you have an external (PID) controller. In this mode the internal controller is turned off. The output frequency changes proportionally based on sensor input (X1/2) and the following chart. Low water, thermal protection and external on/off continue to function.

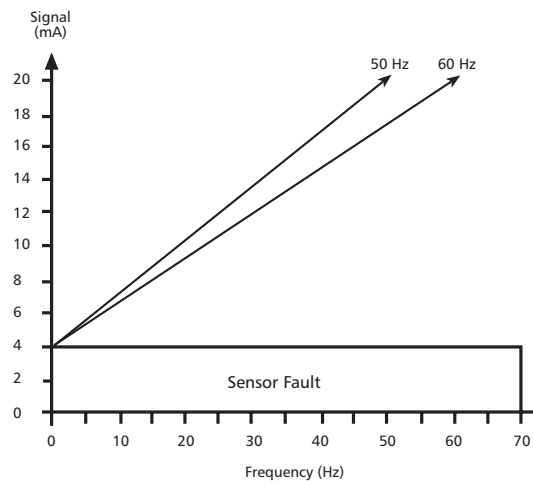

Manual - When this is used, the required value window in the main menu will change to “manual control” and the actual frequency and actual value will be displayed (similar to the Jog Mode). The ▲ and ▼ keys can then be used to set a specific frequency. If saved, this will become the set point after power loss.

Start Value

This allows the operator to set a pressure drop from the required value at which the AQUAVAR II will begin to ramp up, when there is demand. For example, if the required value is 50 psi and the start value is set at 45 PSI, the AQUAVAR II will start when system pressure drops to 45 psi. This is useful when small leaks in the system are causing pressure drops, that cannot be repaired.

Config. Required Value 2

This allows you to select the types of second input value in use in a two value system. Refer to Section VII.

Relay Config.

This is used to select the function of the output relay for either motor running or slave pump. See Section IX.

Submenu Offset

A discussion of the various windows and functions of this submenu can be found in Section VIII.

Regulation Mode

The “**Normal**” setting increases the output speed with falling signal (discharge control). The “**Inverse**” setting decreases the output speed with falling signals (suction control).

Operator Custom Features and Displays

Submenu Sequence Control - for further information see Section IX, page 53

Use this menu to allow starting and stopping of up to 4 pumps with the RS-485 communication port. The following setup items allow the user to determine when the pumps will start and stop.

Actual Value Increase

Enter a value to increase the setpoint (required value) after a lag pump starts.

Actual Value Decrease

Enter a value to decrease the setpoint (required value) after a lag pump starts. The required value will be calculated from the following equation after a lag pump starts:

$$\text{NEW REQUIRED VALUE} = \text{REQUIRED VALUE} - \text{ACT. VALUE DEC.} + \text{ACT. VALUE INC.}$$

For no modification to the setpoint keep both of the increase and decrease values at the same value.

Enable Sequence Control

Enter the maximum speed prior to starting the lag pump(s). Typically set a +2 HZ below the maximum frequency. To disable pump staging set this value greater than the maximum frequency.

Switch Interval

Enter the amount of time the lead pump should operate prior to alternating the pump sequence. This variable allows equal wear on all controlled pumps. Set this value greater than 100 hours to deactivate alternation.

Source Required Value

Used to set the address for the source of a second required value. May be set to off, ADR1, ADR2, ADR3 or ADR4.

Submenu Synchronous Control

To use this method of multiple pump control, all pumps must be exactly the same. When the synchronous control is active all of the activated pumps work together to satisfy the required value. When the synchronous control is deactivated the lead pump(s) run at full speed while the lag pump modulates in speed to satisfy the required value.

Synchronous Limit

To deactivate synchronous control, set this value below 0 HZ. This will be the lowest speed that multiple pumps will operate prior to switching off the last pump in sequence. For 60 Hz systems using synchronous mode, this would normally be set to 40 Hz. This window is also used for the stop value of a slave pump.

Synchronous Window

This is a frequency offset that increases the synchronous limit that each lag pump is stopped at. This allows the minimum speed to be increased for each lag pump. For example, if the synchronous limit were set for 40 Hz and the synchronous window is set for 50 Hz. Pump 3 shuts off at 45 Hz and pump 2 shuts off at 40 Hz.

Operator Custom Features and Displays

Pump Sequence

This screen is located in the Sequence Control Submenu and displays the address and status of the pump as follows:

- AdrX *** Pump address 1-4 is displayed as assigned by the operator during system set up. If the * is displayed, this is the address for this pump.
- hold Px** The pump is off and the pressure/flow regulator is working.
- run Px** The pump is running and the pressure/flow regulator is working.
- stop Px** The pump is stopped and the pressure/flow regulator for this pump is blocked.
- disabled** The AQUAVAR II controller is not ready to start (Autostart on the main menu is off).
- error** There is a fault in the AQUAVAR II controller operation. This will be identified in the error displays (see pages 67-68).
- fault** There is a problem with communication to other pumps via the RS-485 connection.
- detected** Communication with other pumps via the RS-485 connection is enabled.

Bus ARBIT

The Data Bus Diagnostic display is a warning which shows the number of attempts used by the RS-485 interface to synchronize the pump controllers in the system. In a multiple pump system, each AQUAVAR II controller must be set to the same operating parameters. If this is not the case, or if there is some mechanical or electrical block to the signal, the display will indicate a fault. To clear the display, unplug the AQUAVAR II controller for about one minute.

Pump - Address

If only one unit is used the proper setting is "OFF". If 2 through 4 units are installed, each pump must be assigned a unique address number.

ADC Reference

This setting tells the unit where to look for the actual value signal. Set to "LOCAL" if the actual value is obtained from a 4-20mA transmitter wired to the unit's actual value input terminals (X1: 2, 3). Set to "REMOTE" if the actual value is obtained from the RS-485 port via a remote device.

Frequency Lifting

Allows modification of the required pressure to accommodate for system frictional losses due to increased flow. Enter the speed at which system losses are a concern and compensation should begin to be added to the required pressure. Typical settings are 40 HZ for a 60 HZ motor and 30 HZ for a 50 HZ motor. See section III for more information.

Lift Intensity

Enter a value for increasing the required pressure due to frictional losses once the frequency lifting speed is exceeded. Calculate the pressure drop due to frictional losses and divide by the required pressure and input this value as a percentage. Enter 0% if frictional losses are of no concern.

Reference

This display is located in the RS-485 Submenu and shows whether control is being received from the local ADC (Analog/Digital Converter) or from another source shown as "SIO" via the RS-485 interface.

Operator Custom Features and Displays

Analog Out

It is possible for the AQUAVAR II controller to supply an output signal from 0-10 Volts at a maximum of 2 mA. Connection of the outside recording device (such as a meter) is done at terminals 1 (analog return) and 2 (output signal) of terminal strip X9 inside the AQUAVAR II controller drive. The **"Analog Out"** display allows you to display pressure as the output to be displayed. 0-10 Volts equals 0-100% of displayed pressure.

Pressure Units

This display allows the user to select Bar, PSI, or meters of water for pressure or gallons per minute for flow, or percent. If percent is selected, the percentage displayed will be the percentage of the maximum sensor value.

Test Run

The AQUAVAR II controller can carry out a test run of the pump either automatically or manually. For automatic settings, enter the number of hours you want to elapse between the last pump shut down and the test. Possible settings are between 10 and 100 hours. When the time has elapsed, the pump will automatically turn on at 50% of maximum frequency (normally 30 hz) for 20 seconds and then turn off again.

Note

This will only work when the Auto Start function on the main menu is on. If you do not want to use the automatic test run function, you can turn it off by selecting 100 hours, and then pressing the up and down arrows at the same time until the display changes to deactivated.

Submenu Test Run Manual

To conduct a manual test run of the pump, enter this submenu by holding down on the **S** key. The first display in the submenu is the activation display for the test run. To start the test, press the up and down arrow keys at the same time. If you want the test to be conducted at some other frequency than 30 hz, use the next display in the submenu: **Test Frequency**. This can be set from 6-60 hz. When finished, hold down on the ***** button until the display returns to the Submenu display.

Submenu Errors

Two of the functions in this submenu have been covered: **Conveyor Limit** (used to set system shut off when maximum flow is exceeded) and **Delay Time** (used to set pump shut off in conjunction with conveyor limit and a suction side pressure switch or float). The remaining displays in this submenu are used to show the cause of failure in the last three instances where a pump or system failure caused the AQUAVAR II controller to turn the pump off.

Within the **Error Submenu**, the **Error Reset** display allows the operator to tell the AQUAVAR II controller to re-try pumping after a non-fatal fault. When turned on, the AQUAVAR II controller will retry up to five times before shutting the unit off. If Error Reset is off, the AQUAVAR II controller will shut down the system the first time a fault occurs. In both cases, the AQUAVAR II controller can be

Operator Custom Features and Displays

reset by removing all power to the unit for at least one minute. This will reset the fault counter to zero. **NOTE:** Error reset will not apply to “Low Water Switch” on terminals X1, 6 and 7. If this contact is “Open”, the AQUAVAR will stop after the delay time.

Clear Errors

This display allows you to clear all error memory by entering a password. Enter 0726 in “Clear Errors” screen and press “★” key.

Operating Hours

This counter displays the total amount of time that the AQUAVAR II controller drive head has operated, (whether the pump was running or not). This time can be reset to zero by pressing the up and down arrows at the same time for 25 seconds.

Total Run Time

This display shows the total run time of the pump motor in hours and minutes. This display resets automatically when Operating Hours is reset.

Display Contrast

This display allows the operator to set the contrast of the LCD display on the control panel from 10% to 100%. Use the up and down arrows to set the contrast desired.

Set Password

The pre-set factory password is 0066. This display allows you to create a new password for security. If you decide to change the password, **write it down and store it in a safe place.**

NOTE

YOUR GOULDS DISTRIBUTOR OR APPLICATION ENGINEER WILL NOT BE ABLE TO HELP YOU WITH PROGRAMMING PROBLEMS IF YOU HAVE CHANGED THE PASSWORD AND LOST IT!

Lock Function

This allows the operator to lock all of the settings on the main menu except On/Off. When the lock function is off, main menu settings may be changed normally. On pre-packaged systems, the lock function will assure that package settings remain as selected at the factory.

Default Values

Default values can be set for either US or Europe base data. The US default is PSI, 60 Hz, etc. To return all settings to the pre-programmed factory settings: press the up and down arrow keys at the same time and hold them as a count down timer counts back from 5 to 0. When complete, the display will return to the main menu and show Inverter - Stop/Default. All settings can be entered again following the directions given in the Programming Section. After loading default values, the screen will flash until values are saved.

Save ??

This display allows any program changes to be saved and return to the main menu. **Remember that all program changes will be cancelled when the system is turned off unless these are saved.**

Repair of Faults and Errors

WARNING



DISCONNECT POWER FROM THE AQUAVAR CONTROLLER BEFORE CONNECTING THE FAULTS TO AVOID POTENTIAL FOR AUTOMATIC PUMP RESTART.

Lack of Water

This error message will be displayed when a switch has indicated that the incoming water pressure or water level in a suction tank falls below the required NPSH of the pump. If suction conditions appear to be correct, check the pressure switch or float switch to make sure it is operating properly. When the suction conditions have returned to normal, the pump will restart automatically. This message will also appear if terminals 6 and 7 on terminal block X1 are not bridged.

Conveyor Control (Value Range Control)

The drive is not able to obtain the minimum required value set in the conveyor limit setting. Look for potential reasons for the low signal or lower the "CONVEYOR CONTROL" or increase the "DELAY TIME" settings.

Error 1 through Error 8

These are program errors within the AQUAVAR II controller control system. If one of these errors occurs, turn the unit off for at least 30 seconds and then back on. If the error is displayed again, contact your Goulds Pumps AQUAVAR II distributor with an exact description of the fault.

Error 1 Eprom Error

Error 2 Security Software Protection Error

Error 4 Keyboard Error, check pushbuttons for proper actuation, or buttons may be held down by the cover being on too tight.

Error 5 Eprom Error

Error 6 Watchdog Error

Error 7 Processor Pulse Error (Failure of oscillator for processor)

Error 8 Invalid Processor Command Error, power wires and motor leads may be too close to the control board or communication ribbon.

Pressure Sensor Error

The pressure or flow sensor is out of order, not connected properly, not zeroed properly, or the cable is damaged. Check the sensor and zero object and then turn the unit back on.

Actual Value Sensor Error (Act. Val. Sens. Error)

The AQUAVAR does not receive a 4-20 mA signal from transmitter. Check transducer wiring, connections and for the 4-20 mA signal. Once corrected, turn power off for at least 30 seconds to restart.

Inverter Error

A problem or error has occurred in the internal drive. Check the active fault history on internal display, page 70. Press **SHIFT + ENTER** keys to read fault history and fault codes, Diagram 20, page 70, for list of fault codes.

Repair of Faults and Errors

External Device Error

This indicates that there is an electrical problem with the input line, drive or pump motor. To determine the exact problem, open the front panel door and read the error message on the internal display.

Active Fault/Warning and Fault History Mode

When a fault or warning occurs, the Operate mode automatically changes to the Active Fault mode. The drive stores up to three active faults or warnings and provides a separate display for each. Diagram 20 provides a sample display for an active fault.

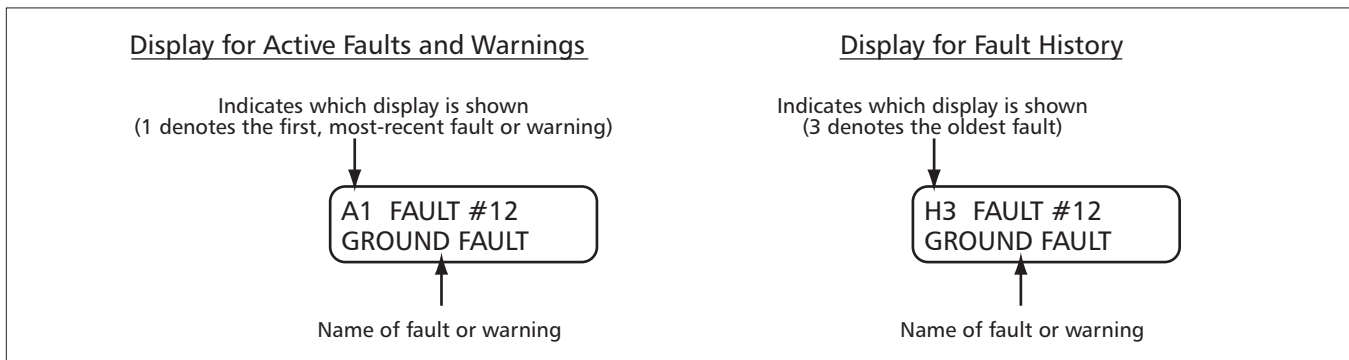

Diagram 20

Once the active fault display is shown, you must correct the condition causing the fault and then reset the drive to return to the Operate mode. However, if all three active fault displays only show warnings, you may return to the Operate mode by pressing **SHIFT + ENTER**.

In addition to the active faults, the drive maintains a history of faults. The three most-recent faults are kept in the fault history log. The log is accessed by pressing **SHIFT + ENTER**. As shown in Diagram 20, the display is the same as for active faults, except that an H is shown in the upper left corner. (See Table 13 for a description of fault codes.)

After viewing the fault history log, return to the Operate mode by pressing **PROG** twice.

Table 13: AQUAVARII Electrical Fault Codes

Fault Code	Fault Name	Possible Cause(s)	How to Recover
01	Watch Dog Trip	Consult Factory	Consult Factory
02	Power Bridge ID	<ul style="list-style-type: none"> Ribbon cable not correctly seated between the power and control boards. Electrical noise. 	<ul style="list-style-type: none"> Ensure that the ribbon cable is correctly seated. Determine the source of the noise and eliminate it.
03	Current Calibr	Current sensors have an offset problem.	Consult factory.

Repair of Faults and Errors

Table 13: AQUAVAR Electrical Fault Codes (continued)

Fault Code	Fault Name	Possible Cause(s)	How to Recover
04	TSP 24V Supply	Overloaded +24 Vdc supply.	Check the loading on the +24 Vdc supply and remove any excess load.
05	DC Volt Calibr	DC voltage is outside of normal limits on power-up. This may be caused by: <ul style="list-style-type: none"> • High or low line voltage. • Supply voltage parameter incorrectly set. 	<ul style="list-style-type: none"> • Check line voltage. • Check the Supply Voltage parameter.
06	IOC Trip	Output short-circuit. May also be caused by a ground fault (see Fault Code 11 below).	<ul style="list-style-type: none"> • Check motor wiring. • Extend acceleration ramp. • Reduce boost. • Check for ground faults.
07	Ext Flt/Warning (Fault)	The configured input sensed an external fault.	Investigate why the external fault occurred and correct.
09	Inter-Proc Comm	Loss of communication with the control terminal strip.	Reset the drive by pressing the Stop key for more than 1 second. If problem persists, consult the factory.
11	Ground Fault	The drive detected that the sum of the motor phases' current is not zero. This may be caused by insulation failure in the motor or the cables.	<ul style="list-style-type: none"> • Check motor wiring. • Check for and remove any capacitive load. • Check the motor and cabling for shorts to ground.
12	Input Phase Loss	Current measurement detected an input phase with no current.	Check input power cables.
13	Overvoltage	The voltage of the internal DC-link has exceeded 135% of the Nominal voltage. This may be caused by incorrect deceleration time or high overvoltage spikes on line.	<ul style="list-style-type: none"> • Adjust deceleration time. • Add dynamic braking module.
14	Under Voltage	The DC bus voltage fell below 65% of the nominal voltage. This may be due to line supply failure or internal failure of the drive.	Reset fault and attempt to restart. Check the line for proper supply. If fault persists, an internal fault has occurred; contact the factory.

Repair of Faults and Errors

Table 13: AQUAVAR Electrical Fault Codes (continued)

Fault Code	Fault Name	Possible Cause(s)	How to Recover
16	Motor Over Temp (Fault)	The drive's motor temperature model detected motor overheating severe enough to cause a fault.	Decrease motor loading. If the motor is not overheated, check the temperature model parameters.
17	Output Fault	The output sensor detected an error.	<ul style="list-style-type: none"> • Check motor wiring. • Check for and remove any capacitive load. • Check the motor and cabling for shorts to ground.
18	Overcurrent	The drive has measured excessive current in the motor output. This may be caused by: <ul style="list-style-type: none"> • Sudden, heavy load increase. • Short circuit in the motor cables. • Unsuitable motor. 	<ul style="list-style-type: none"> • Check the load, motor size, and cables. • Review the settings for acceleration and deceleration times.
19	Drive Over Temp	Temperature of the drive's heatsink is too high.	<ul style="list-style-type: none"> • Check the air flow. • Check that the heatsink is not clogged. • Check the ambient temperature. • Check that the switching frequency is not too high compared to ambient temperature and load.
20	Motor Overload	Excessive load on the motor (for example, a jammed load.)	Check the motor and load.
21	Drive Under Temp	<ul style="list-style-type: none"> • Temperature of the drive's heatsink is below 0°C (32°F). • Ribbon cable not correctly seated between the power and control boards. 	<ul style="list-style-type: none"> • Increase the ambient temperature. • Ensure that the ribbon cable is correctly seated.
22	Motor Stall (Fault)	The motor's stall protection sensed a stall severe enough to cause a fault.	Check the motor.

Repair of Faults and Errors

Table 13: AQUAVAR Electrical Fault Codes (continued)

Fault Code	Fault Name	Possible Cause(s)	How to Recover
23	Motor Underload	The load on the motor is so insufficient (for example, a broken conveyor belt) that a fault occurs.	Check the motor and load.
24	TSP 10 V Ref	10 V reference for the analog input is overloaded.	<ul style="list-style-type: none"> • Ensure that the total load on the +10 terminal does not exceed 20 mAdc. • Check for correct connection of devices to the +10 terminal. • Check for short circuits associated with devices connected to the +10 terminal. • Consult factory.
25	EE Ref Checksum	Parameter restoring error due to interference fault or component failure.	Reset the fault and attempt a restart. If fault persists, contact the factory.
26	EE Par Checksum	Parameter restoring error due to interference fault or component failure.	Reset the fault and attempt a restart. If fault persists, contact the factory.
27	EEPROM Checksum	Parameter restoring error due to interference fault or component failure.	Reset the fault and attempt a restart. If fault persists, contact the factory.
28	Outpt Phase Loss	Current measurement detected a motor phase with no current.	Check motor cables.
29	Precharge Fault	Consult factory.	Consult factory.
30	TRIN Flt (ASIC)	Consult factory.	Consult factory.
31	Satur Flt (ASIC)	Consult factory.	Consult factory.
32	Empty Trp (ASIC)	Consult factory.	Consult factory.
33	Appl Change	Consult factory.	Consult factory.
34	High Unbal Curr	Consult factory.	Consult factory.
35	MCP Software	Consult factory.	Consult factory.
36	Loss of Ref (Fault)	The drive detected the loss of the reference signal.	Restore the reference signal.
37	Loss of Ref (Warning)	The drive detected the loss of the reference signal.	Restore the reference signal.
38	Broken Wire Trip (Fault)	The drive detected a broken wire to Analog Input 1.	Check the control wiring for a broken wire and replace.
39	Broken Wire Trip (Warning)	The drive detected a broken wire to Analog Input 1.	Check the control wiring for a broken wire and replace.

Repair of Faults and Errors

Table 13: AQUAVAR Electrical Fault Codes (continued)

Fault Code	Fault Name	Possible Cause(s)	How to Recover
40	Loss of Keypad	Communication with the keypad is lost while keypad control is active.	Investigate and correct communication problem.
41	Ext Flt/Warning (Warning)	The configured input sensed an external fault.	Investigate why the external fault
42	Ser Lnk TimeOut	The watchdog timer for Modbus serial communications timed out.	Reset and restore serial link communications.
43	DI Logic Not Set	DI active logic is not set.	Set DI active logic via Active Logic parameter.
44	DI Logic Changed	Consult factory.	Consult factory.
50	Fan Fault	The cooling fan on the drive's enclosure is drawing too much current, which may indicate that the fan is jammed or has failed.	Remove obstruction. Replace fan.
51	Fan Warning	The cooling fan on the drive's enclosure is drawing excessive current, but not enough to generate a fault. This may indicate that the fan is jammed.	Remove obstruction.
52	Motor Over Temp (Warning)	The drive's motor temperature model detected motor overheating, but not severe enough to generate a fault.	Decrease motor loading. If the motor is not overheated, check the temperature model parameters.
53	Motor Stall (Warning)	The motor's stall protection sensed a stall, but not severe enough to cause a fault.	Check the motor.
54	Motor Underload (Warning)	The load on the motor is insufficient, but not so low that a fault occurs.	Check the motor and load.
55	DeviceNet Timeout (Fault)	No DeviceNet communication has occurred in the specified amount of time, and a fault occurs.	Reset and restore DeviceNet communication. See the DeviceNet manual for further information.
56	DeviceNet Timeout (Warning)	No DeviceNet communication has occurred in the specified amount of time, and a warning occurs.	Reset and restore DeviceNet communication. See the DeviceNet manual for further information.
57	Network Ext Fault	The external communication network delivered a command to the drive that is forcing a system-wide error.	Reset and restore DeviceNet communication.
58	Ser Lnk TimeOut (Warning)	The programmed value of parameter Comm Timeout was exceeded.	Reset and restore serial link communications.

↔ AQUAVAR Controller Flow Chart

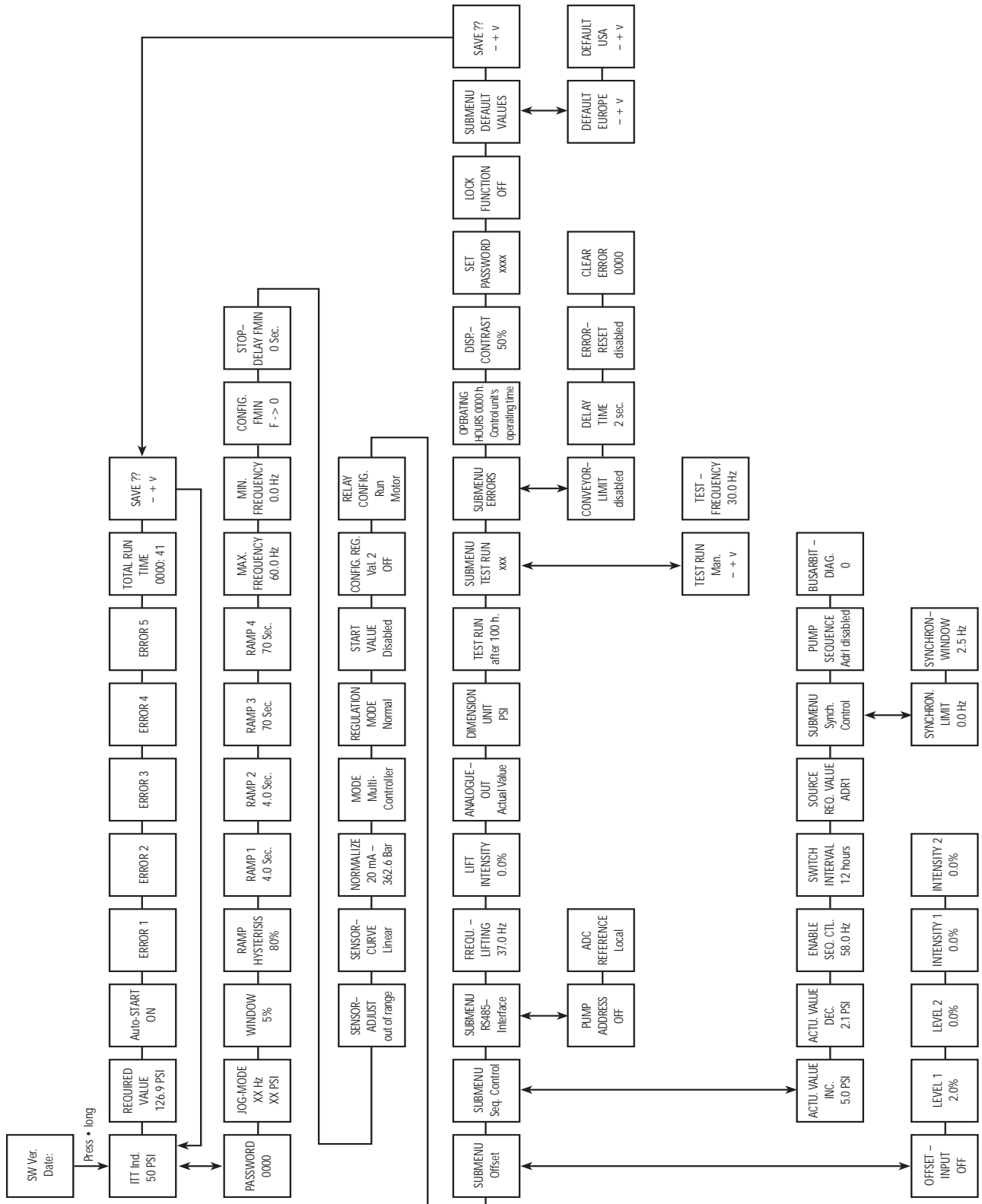

Diagram 21

? Help Windows

You can access a help display at any time by pressing the "★" and ▲ keys at the same time. This will change the second line of the window to a "running" text which provides more information about the window function. The following list shows the normal window text and the available help text. (NOTE: You can access this help text in any program window, hold "★" and ▲ keys!)

Window text	Help Text
No Autostart / ITT Industries Disable Inverter / X.XX PSI	Spanish > Inc.; English > Dec; French > Select, to change language, see page 28 "Note".
Required Value X.XX PSI	Input Required Pressure / Flow for Value #1 or Value #2.
Auto-Start Off (Default)	ON > Autostart enable; Off Autostart disable. Default is "ON", allows auto operation of AV II.
Error 1	Last Error the unit has experienced.
Error 2	4th recorded error.
Error 3	3rd recorded error.
Error 4	2nd recorded error.
Error 5	1st recorded error.
Total Run Time 0000:00	Total motor run time hh:mm.
Save ??? Inc + Dec	Press INC + DEC to save parameter values. Always save changes to programming.
Password 0000	Enter Password. Default is 0066.
Jog Mode 0.0Hz XX.XX PSI	Jog Mode: frequency controlled by Inc or Dec. Displays the motor frequency and pressure for manual control of motor, press the up arrow or down arrow.

Help Windows

Window text	Help Text
Window 5%	Pressure window, percentage above and below set pressure. See pages 61 and 62.
Ramp Hysteresis 50%	Hysteresis, part of the window. See pages 61 and 62.
Ramp 1 4.0 Sec	Ramp 1: fast acceleration time. (Ramp up speed.) See page 62. Set higher for larger HP motors.
Ramp 2 4.0 Sec.	Ramp 2: fast deceleration time. (Ramp down speed.) See page 62. Set higher for larger HP motors.
Ramp 3 50 Sec.	Ramp 3: slow acceleration time. See page 62.
Ramp 4 50 Sec.	Ramp 4: slow deceleration time. See page 62.
Max. Frequency 60.0 Hz	Maximum output frequency range: 6 - 70 Hz, see page 62.
Min. Frequency 0.0 Hz	Minimum output frequency (range: 0 - max. frequency). See pages 43 and 63.
Config. F Min f->0 or f->F Min	Configuration behavior at minimum frequency, see page 63.
Stop-Delay Time 0 Sec.	Delay for pump stop when f->0 is chosen, see page 63.
Sensor Adjust? Out of Range	Sensor zero adjustment (press inc + dec). See page 63.
Sensor Curve (Linear or Quadratic)	Sensor characteristic curve (linear is default). See page 63.
Sensor Range 20mA = 25.0 bar (367.6 PSI)	Normalize to maximum sensor value, adjust to sensor's maximum value. See page 63.
Mode: Controller	Mode: controller > pressure control; Actuator > frequency set point as ADC Value Multicontroller > control of up to 4 pumps. Synchronous > All motors synchronized for same speed operation. See page 64.

Help Windows

Window text	Help Text
Regulation Mode (Normal Default)	Pumping regulation mode, normal or inverse. See page 64.
Start Value PSI or Selected Units	Start value, allows pressure to drop in system before unit starts. (Disabled is default) See page 64.
Config. 2nd Required Value Off (Default)	Configuration of a second value from another sensor. See page 64.
Relay Configuration Run Motor (Default)	Relay configuration. See page 64.
Submenu Offset	Submenu offset: to enter push " ★ " key for at least two seconds.
Offset Input Off (Default)	Selection of offset input, if required. See page 49.
Level 1 XX.X %	Start level for offset 1. See page 50.
Level 2 XX.X%	Start level for offset 2. See page 50.
Intensity 1 XX.X%	Intensity of offset 1. See page 51.
Intensity 2 XX.X%	Intensity of offset 2. See page 51.
Submenu Seq. Control	Submenu seq. control; to enter push " ★ " key for at least two seconds. See pages 52 and 53.
Pressure Incr. 4 PSI	Pressure increment at switching of additional pumps in multicontroller mode. See pages 52 and 53.
Pressure Dec. 4 PSI	Pressure decrement for consecutive pumps. See pages 52 and 53.
Enable Seq. Ctl. 58 Hz (Default)	Frequency limit enable sequence control. Starts second pump in multicontroller. See page 55, step 9.
Switch Interval 12h (Default)	Time interval pump sequence change. Allows multiple pumps to lead/lag in system, based on switch interval time. See page 55, step 10.

Help Windows

Window text	Help Text
Submenu Synch. Control	Submenu: synchronous regulation; to enter push select at least one second. See page 56.
Synchron Limit 35.0 Hz	Frequency limit to enable the synchronous regulation. See page 56, step 11.
Synchron Window 5.0 Hz	Frequency offset for the frequency limit which activates the synchronous regulation. See page 56.
Pump Sequence Adr 1 Hold P1	Diagnostics: Pump sequence and status. Identifies address numbers and pump numbers in multi-controller mode and synchronous mode.
BUSARBIT DIAG 0	Diagnostics: Bus arbitration (this pump). Diagnostics only, do not adjust.
SUBMENU RS485 Interface	Submenu: Serial Interface; to enter push " * " key for at least two seconds.
Pump Address Off	SIO address of the pump, for addressing each AV II in multicontroller mode.
ADC Reference Local (Default)	Pressure or frequency reference enabled by local ADC or by SIO.
Frequency Lifting 30.0 Hz	Frequency limit for pressure lift.
Lift Intensity 0.0%	Max. lift in % of pressure set point at max. frequency.
Analog Out Actual Value	Meter output: frequency; pressure.
Dimension Unit PSI	Displayed dimension unit.
Test Run After 24 h	Time interval for test run 10 - 100 hr. or deactivated (inc+ dec).
Submenu Test Run Man.	Submenu pump test manual; to enter push select at least one second.

Help Windows

Window text	Help Text
Test Run Man. (Inc + Dec)	Start test run with up and down arrows simultaneously.
Test Frequency 30.0 Hz	Test frequency. Frequency at when motor will run in test mode.
Submenu Errors	Submenu: errors; to enter push " * " key for at least two seconds.
Conveyor Limit	Value at which pump system shall be deactivated, due to lack of NPSH or system pressure.
Delay Seconds Disabled (Default)	Enter a time the pump is allowed to run after a suction line sensor has activated, or conveyor limit has been reached.
Error Reset On	Automatic error reset measured in seconds. The AV II will restart 5 times. If error is still present, the AV II will stay off on faults.
Clear Errors 0000	Clear error history, enter 0726 and press the " * " key.
Operating Hours xxxxh	Total AQUAVAR controller operating time (reset counters: press the up and down arrows).
Disp. Contrast 100%, 50% Default	Display contrast, 0-100% contrast.
Set Password 0000	Modify password enables the user to set a new password.
Lock Function Off	On > keypad locked: off > changes allowed.
Submenu Default Values	Submenu load default parameters to enter push select at least 1 second.
Default USA/Europe Press up and down arrows (if needed).	Reset to default parameters for US or European settings.
Save ??? Inc + dec	Press Inc + Dec to save entered values

Appendix A

Pressure Transducer Data

Series 1200

Specifications

Measuring Range (FS):	.52 bar	10 bar	25 bar	(other ranges upon request)
Over-Pressure (P _{MAX}):	2 bar	40 bar	100 bar	
Class of protection:	IP 65 (Nema 4)			

Type

Output-Signal:

Supply:

Linearity:

Stability:

Total Error:

Operating Temperature:

Material: Body and diaphragm: 17-4 PH

Sealed gauge:

4-20mA; 2 wire

7-35 VDC

0.5% FS

0.2% FS max.

2% FS

-22°F to 260° F

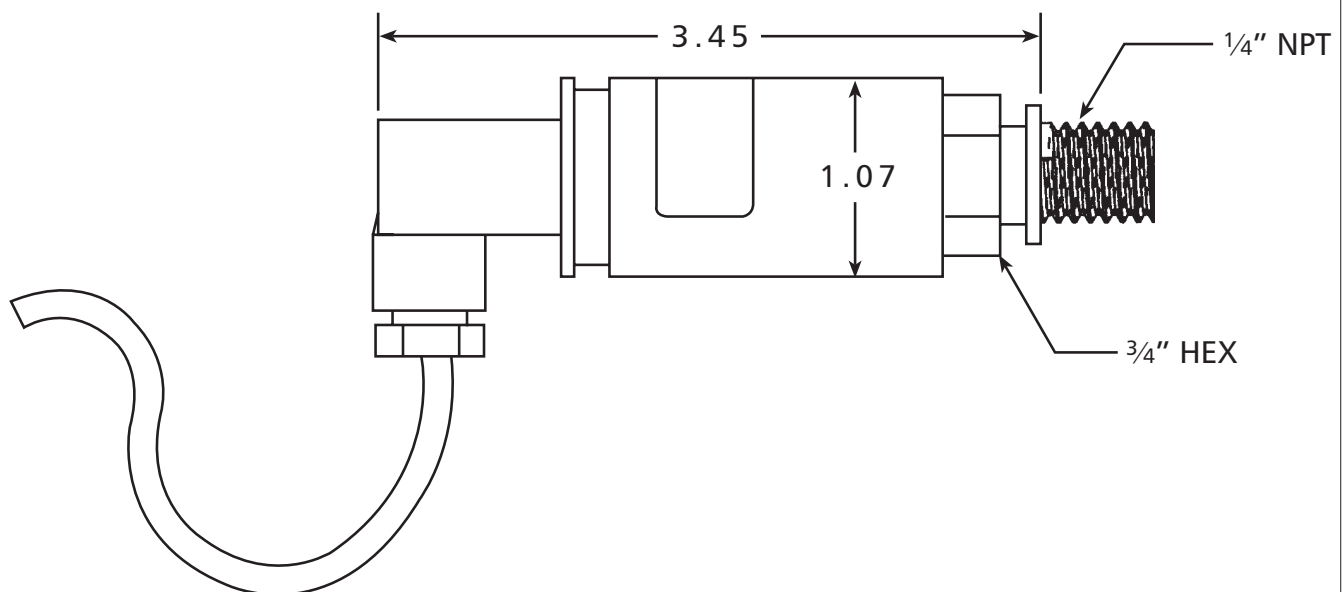

Diagram 22

Appendix A

Differential Pressure Transmitter

Series PD-39S

The sensors of this differential transmitter are two piezoresistive silicon pressure sensors, mounted on a tape (TAP), freely floating in an oil chamber. The pressure is transferred to the sensor by a separating steel diaphragm in the oil chamber.

Plug: mPm 193
incl. 2 m cable

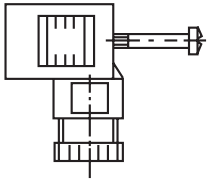

Cable:
Out (white)
+ Vcc (brown)
Screen

Screw joint and cover:

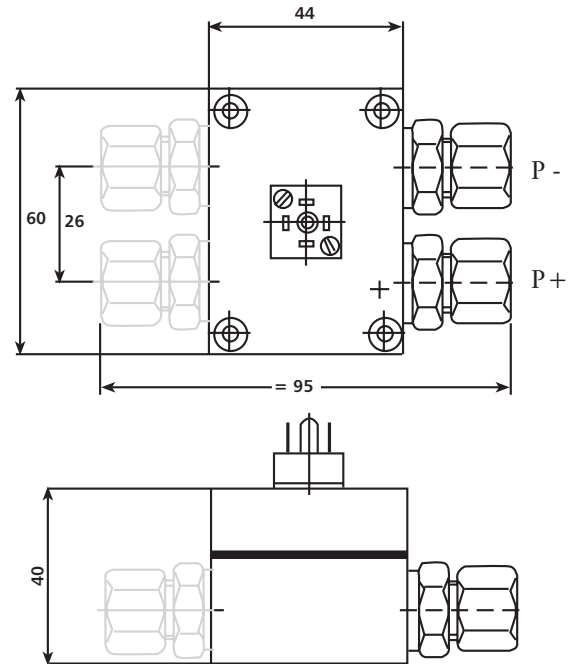

Diagram 23

Specifications

Measuring Range (FS):	0,4 bar	4 bar	10 bar	<i>Differential</i> (other ranges upon request)
Over-Pressure (P _{MAX}):	16 bar	16 bar	16 bar	Single-sided
Class of protection:	IP 65	IP 65		

Type

Output-Signal:

Supply:

Load resistance:

Linearity:

Stability:

Operating Temperature:

Storage Temperature:

Material: Body and diaphragm: 1.4435 stainless steel

Sealed gauge:

4-20mA; 2 wire

8-28 VDC

max. 50Ω at supply voltage = 10VDC

± 0.2% FS; max ±0.5% FS

± 0.1% FS; max ± 0.2% FS

-20° to +80° C

-40° to +120° C

Appendix A

Pressure Transducer Data

Model Delta 692 Differential Pressure Transducer and Orifice Plate

Specifications	Standard 80096 ND
Range (FS)"	2, 5 bar - 37 PSI
Over Pressure (P _{MAX})	12 bar - 177 PSI
Signal over Range	4... 20mA; 2 wire
Power Supply	9... 33 volts DC
E1 Connection	DIN-plug 43650

Hydraulic connection	R 1/8"
Linearity	tip ± .25%FS; max. ± .5%FS
Stability	tip ± .1%FS; max. ± .5%FS
Operating Temperature	-15° - 80° C
Storage Temperature	-15° - 80° C
Materials	Stainless steel (body) Ceramic (diaphragm)

Nominal Pipe/ Discharge Size	Constant Flow Range
1"	12-35 GPM
1"	18-52 GPM
1 1/2"	20-62 GPM
1 1/2"	32-90 GPM
2 1/2"	35-105 GPM
2 1/2"	52-160 GPM
3"	52-160 GPM
3"	70-210 GPM
3"	120-350 GPM

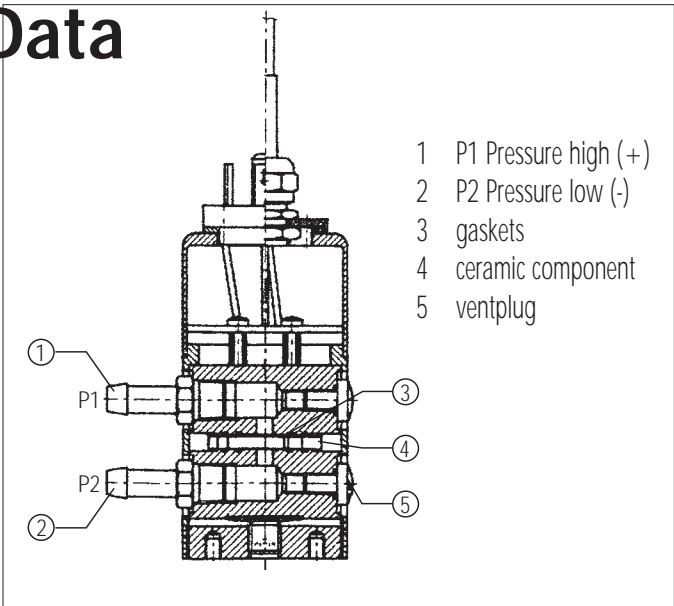

Diagram 24

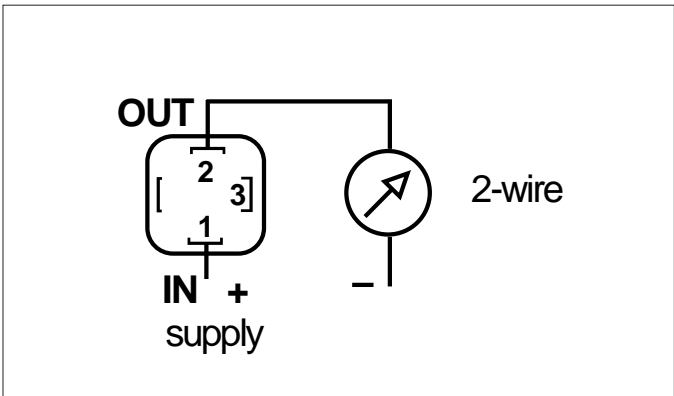

Diagram 25

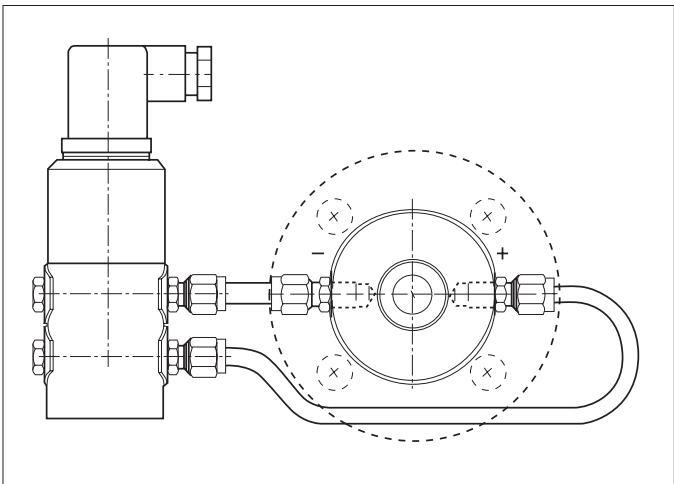
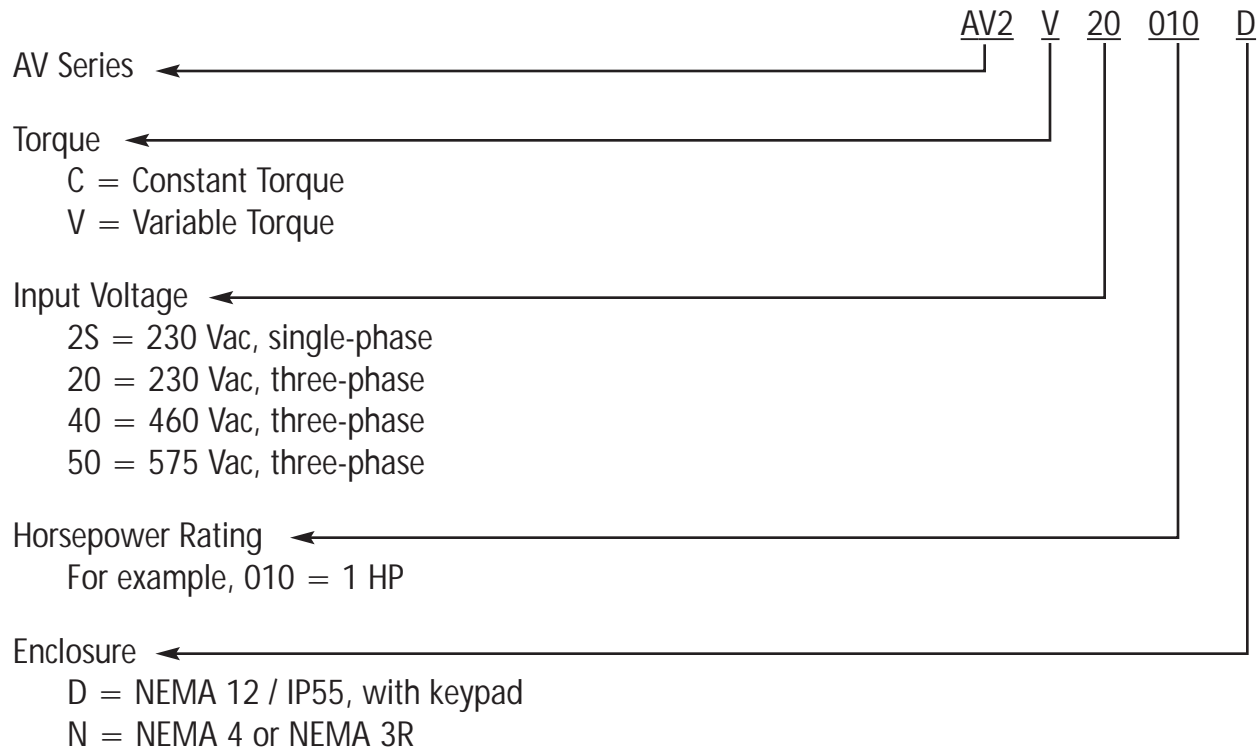

Diagram 26

Technical Characteristics

Interpreting Model Numbers

The model number of the AQUAVAR appears on the shipping carton label and on the technical data label affixed to the model. The information provided by the model number is shown below:



Power and Current Ratings

Model Number	Motor Power		Input		Output Voltage (Vac)	Maximum Load Output Current (A)		
	HP	kW	Voltage (Vac)	Maximum Current (A)		200/380 Vac	230/460/575 Vac	
				200/380 Vac				230/460/575 Vac
AV2V2S010D	1.0	0.7	Single-phase 200 to 230 ±15%	—	8.9	0 to 230	4.8	4.2
AV2V2S020D	2.0	1.5		—	16.2		7.8	6.8
AV2V2S030D	3.0	2.2		—	23.1		11.0	9.6
AV2V2S050D	5.0	3.7		—	32.9		17.5	15.2
AV2V2S075D	7.5	5.5		—	47.5		25.3	22.0
AV2V2S100D	10.0	7.5		—	62.8		32.2	28.0
AV2V20010D	1.0	0.7	Three-phase 200 to 230 ±15%	5.6	4.8	0 to 230	4.8	4.2
AV2V20020D	2.0	1.5		9.0	7.8		7.8	6.8
AV2V20030D	3.0	2.2		12.7	11.0		11.0	9.6
AV2V20050D	5.0	3.7		20.2	17.5		17.5	15.2
AV2V20075D	7.5	5.5		29.2	25.3		25.3	22.0
AV2V20100D	10.0	7.5		37.2	32.2		32.2	28.0

Technical Characteristics

Power and Current Ratings (continued)

Model Number	Motor Power		Input			Output Voltage (Vac)	Maximum Load Output Current (A)	
	HP	kW	Voltage (Vac)	Maximum Current (A)			200/380 Vac	230/460/575 Vac
				200/380 Vac	230/460/575 Vac			
AV2V20150D	15.0	11.0	Three-phase 200 to 230 ±15%	52.1	46.4	0 to 230	48.3	42.0
AV2V20200D	20.0	15.0		53.9	47.4		62.1	54.0
AV2V40010D	1.0	0.7	Three-phase 380 to 460 ±15%	3.4	2.4	0 to 460	2.4	2.1
AV2V40020D	2.0	1.5		5.2	3.9		3.8	3.4
AV2V40030D	3.0	2.2		7.2	5.6		5.7	4.8
AV2V40050D	5.0	3.7		12.0	8.8		8.9	7.6
AV2V40075D	7.5	5.5		15.0	12.8		12.0	11.0
AV2V40100D	10.0	7.5		19.7	16.3		15.6	14.0
AV2V40150D	15.0	11.0		30.9	25.8		23.0	21.0
AV2V40200D	20.0	15.0		40.0	33.3		31.0	27.0
AV2V40250D	25.0	18.6		49.2	40.0		37.0	34.0
AV2V40300D	30.0	22.0		57.5	47.8		43.0	40.0
AV2V40400D	40.0	30.0		62.3	53.3		61.0	52.0
AV2C40500D	50.0	37.0		71.0	65.0		71.0	65.0
AV2C40600D	60.0	45.0		86.0	77.0		86.0	77.0
AV2C40750D	75.0	55.0		105.0	96.0		105.0	96.0
AV2V40500D	50.0	37.3	69.0	58.0	73.0	65.0		
AV2V40600D	60.0	44.7	82.0	68.8	87.0	77.0		
AV2V40750D	75.0	56.0	98.3	82.2	105.0	96.0		
AV2V50010D	1.0	0.7	Three-phase 575 ±15%	—	2.0	0 to 575	—	1.7
AV2V50020D	2.0	1.5		—	3.6		—	2.7
AV2V50030D	3.0	2.2		—	5.0		—	3.9
AV2V50050D	5.0	3.7		—	7.6		—	6.1
AV2V50075D	7.5	5.5		—	10.4		—	9.0
AV2V50100D	10.0	7.5		—	14.1		—	11.0
AV2V50150D	15.0	10.0		—	20.8		—	17.0
AV2V50200D	20.0	15.0		—	27.8		—	22.0
AV2V50250D	25.0	18.6		—	33.4		—	27.0
AV2V50300D	30.0	22.0		—	39.1		—	32.0
AV2V50400D	40.0	30.0		—	52.0		—	41.0
AV2C50500D	50.0	37.0		—	52.0		—	52.0
AV2C50600D	60.0	45.0		—	62.0		—	62.0
AV2C50750D	75.0	55.0		—	77.0		—	77.0

(1) Consult factory.

Technical Characteristics

Power and Current Ratings *(continued)*

Specifications

Environmental MAXIMUM HEATSINK TEMP. = 100° C (212° F)

Operating temperature	0°C to +40°C (32°F to 104°F) *
Storage temperature	-20°C to +65°C (-4°F to 149°F)
Humidity	0% to 95% non-condensing
Altitude	1000 m (3300 ft) without derating *
Acoustic noise	80 dBA sound power at 1 m (3 ft)

Electrical

Voltage input	AV2C2x models: 200 to 230 Vac, ±15% AV2C4x models: 380 to 460 Vac, ±15% AV2C5x models: 575 Vac, ±15%
Input Line frequency	50 / 60 Hz ±2 Hz
Overvoltage trip	407 Vdc 814 Vdc 1017 Vdc (DC BUS Voltage)
Undervoltage trip	202 Vdc 404 Vdc 505 Vdc (DC BUS Voltage)
Output voltage	0 to 100% of line voltage, 3 Phase
Overload capacity	110% of rated rms for 60 seconds
Rated output frequency	50/60 Hz ±5%
Timed overload	Adjustable time trip set for 110% of rated motor current
Agency listing	UL and CUL Listed, CE marked

Control Features

Protective features and circuits	Overcurrent, overvoltage, phase loss, motor over-temperature, overtemperature, ground fault, undervoltage, short circuit, sensor fault.
----------------------------------	---

* For high ambient temperatures, derate HP of drive. Altitudes above 3300 ft. of sea level, derate 2% of HP for every 1000 ft. above 3300 ft. Consult factory for assistance.

Appendix B

AQUAVAR Controller Drive Head Technical Data and Terminals

- Terminals:** There is a terminal strip inside the AQUAVAR controller which will allow the connection of a wide range of external devices for display or control. When using these terminals, shielded wires need to be used. Unshielded wires may produce signal interference which will affect the inverter.
- X1**
- 1 Ground connection
 - 2 Actual value input 4- 20 mA, 50 ohm load resistance. Used to connect external pressure transducer, flow meter, etc. Can also be used as input source from another device signalling actual speed when "actuator" is selected in controller mode.
 - 3 Power source for external transducer 15 V DC, max. 25 mA
 - 4 Ground connection for external on/off
 - 5 External on/off connection, 10 kOhm resistance, 5 VDC gold plated contact. Note that the external device must have a switch suitable for < 10 V. If no outside panel or control is used, a jumper wire is installed on contacts 4 and 5.
 - 6 Ground connection for low water switch.
 - 7 Low water switch connection, 10 kOhm resistance, 5 VDC. This contact is where an external level switch, float switch or pressure switch from the suction line would be installed. If no suction pressure devices are used, a jumper wire is installed on contacts 6 and 7.
 - 8 5 V power source for the Klaxon thermostwitch mounted in the motor conduit box. 10 kOhm resistance. A jumper wire is installed on contacts 8 and 9.
 - 9 Thermostwitch return connection.
 - 10 Ground connection for analog output
 - 11 Analog output connection 0 - 10 V, maximum 2 mA. Can be used to connect an outside meter or display panel to display actual pump running frequency or pressure as selected on the Analog Out part of the program.
 - 12 Current signal input 4-20mA
 - 13 Voltage signal input 0-10V or 2-10V
 - 14 Digital input
- X2**
- 1 Fault signal relay connection. This relay turns on the fault light on the control panel if a fault occurs. This relay may also be connected to an outside panel or display through connections 1, 2, and 3. Each is a maximum 250VAC connection with 1 Amp free of inductivity.
 - 2 Common connection for fault signal relay. 250 VAC with 1 Amp free inductivity.
 - 3 Commonly open connection for fault signal relay. 250 VAC with 1 Amp free inductivity. Connection 3 is commonly closed.

Appendix B

4	** Pump operation signal relay connection. This relay turns on the run light on the control panel when the pump is operating. This relay may also be connected to an outside panel or display through connections 4, 5 and 6. Each is a maximum of 250 VAC with 1 Amp of free inductivity. Connection 6 is commonly closed. Four, 5 and 6 are fault relay's connected to internal drive.
5	** Connected to internal drive. (For fault relay, use internal drive connection.)
6	** Connected to internal drive. (RC2, NC2, NO2, Diagram 8, page 25)
X5/6 1	RS-485 interface connection. SIO - (low) for connection of the AQUAVAR controller to other AQUAVAR controller units in a set, or to an outside controller.
2	RS-485 interface connection. SIO + (high) for connection of the AQUAVAR controller to other AQUAVAR controller units in a set, or to an outside controller.
3	RS-485 interface connection. Common ground.
4	RS-485 interface connection. +5 VAC output signal. Maximum 20 mA output.

Note

When using the RS-485 connection for multiple pump connection, connections X5 1, 2 and 3, must be connected with three core shielded wire to like connections on each AQUAVAR controller drive head.

X9 6	24 VDC supply, connected to drive, control board supply
5*	Connected to drive, +24 VDC power to control board
4*	+24 VDC (jumper wire) connected to drive
3	Connected to drive (fault relay)
2	Analog out signal, 0-10 VDC (pressure reference)
1	Return signal for analog out

* Jumper wire installed at factory, do not remove.

** X2, 4, 5 and 6 contacts are connected to the internal drive for a run light relay. (Pump run) For an external run relay, use internal drive connections on TB3, RC2, NC2, NO2, located in Diagram 8, page 25. TB3 terminal block specifications, located on page 26.

Appendix C

Interference Suppression Measures

Introduction

Electrical/electronic devices are capable of influencing or disturbing each other through connecting cables or other metallic connections. Interference suppression measures (electromagnetic compatibility) consists of two elements: interference resistance and interference emission.

Correct installation of the inverter in conjunction with any possible local interference suppression measures has a crucial effect on minimizing or suppressing mutual interference.

Guidelines for interference Suppression

The following guidelines assume a power source that is not contaminated by high frequency interference. Other measures may be necessary to reduce or suppress interference if the power source is contaminated, and no general recommendations can be given for such cases. Please consult G&L Applications Engineering Department if the following recommended interference suppression measures do not produce the desired result.

Guidelines are as follows:

- When dealing with RFI (radio frequency interference), the surface area of the conductors is a more critical consideration than its cross sectional area. Since high frequency interference does not flow through the entire cross section of the conductor, but tends to stay toward its outer surface (skin effect), braided copper tapes of equal cross section should be used.
- A central grounding point should be used for interference suppression. Route the ground cables radially from this point, avoiding loops which may lead to interference.
- The inverter and all components used for interference suppression, particularly the shield of the motor cable, should be connected over as large a surface area as possible when passing over metallic surfaces. Remove the paint from contact surfaces to ensure a good electrical connection. See Diagram 27 for recommended connection technique.

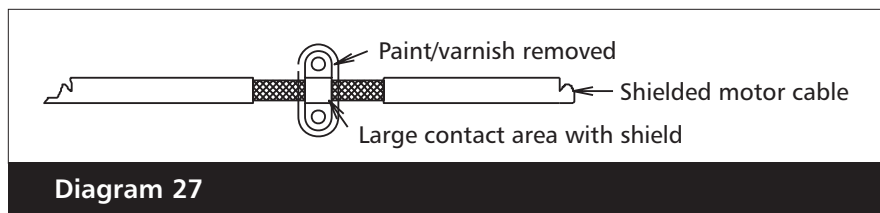

- Take care not to damage the shield cross section when connecting it to the continuing lines. This raises the RF resistance of the shield and radiates rather than discharges the RF energy traveling on the shield. Shields, particularly those on control cables, must not be routed through pin contacts (plug connectors).
- When shielded cables must pass through a plug connection, use the metallic hand guard of the plug for the continuation of the shield. It is strongly recommended that the shield be uninterrupted whenever possible.

Appendix C

- Use a shielded motor cable which is grounded over a large surface area at both ends. The shield on this cable should be uninterrupted. If a shielded motor cable cannot be used, the unshielded motor line should be laid in a metal conduit or duct which is uninterrupted and grounded at both ends.
- When selecting shielded cable for use as motor leads, it is important to select a cable which is designed for operation at the frequencies and power levels involved. Improper selection of motor cable can cause high potential to exist on the shield. This could cause damage to the inverter and other equipment and could pose a safety hazard.
- The following cables are acceptable for this purpose: OLFlex Series 150CY, 110CY, 110CS, 100CY, 100CS and 540CP. Siemens CordaflexSM is also acceptable. Some of these cables are VDE-approved only; others carry VDE, UL, CSA and combinations of these ratings. Be sure to confirm that the cable you are using meets the certification of the agency required.
- OLFlex cables are available from OLFlex Wire & Cable, 30 Plymouth Street, Fairfield, NJ 07004, 1-800-774-3539.
- Cordaflex cables are available from Siemens Energy and Automation, Inc., Power Cables, 3333 State Bridge Road, Atlanta, GA 30202, 1-800-777-3539.
- If the installation requires the use of an output reactor, the reactor, like the line filter, should be placed as close as possible to the inverter.
- Control wires longer than 3 feet (1 meter) must be run in shielded cable and the shield must be terminated at common (CM) on the inverter. Note that connection to CM, the circuit common, rather than earth ground, is allowed because X2C inverters have isolated control inputs. If the signal run exceeds 30 feet (9 meters), a 0-2- mA or 4-20 mA signal should be used, as it will have better noise immunity than a low level voltage.
- Other loads connected to the power source may produce voltage transients (spikes) that may interfere with or damage the inverter. Line reactors or filters can be used on the input power to protect the inverter from such transients.
- If the inverter is operated from switchgear devices or is in close proximity to switchgear devices (in a common cabinet), the following procedures are recommended as a precaution to prevent these devices from interfering with the inverter's operation:
 - Wire the coils of DC devices with freewheeling diodes. The diodes should be placed as close as possible to the physical coil of the device.
 - Wire the coils of AC devices with RC type snubber networks. Place the snubbers as close as possible to the physical coil of the device.
 - Use shielded cables on all control and monitoring signals.
 - Route distribution cables (for example, power and contactor circuits) separately and as far away from control and monitoring signal cables as possible.

GOULDS PUMPS LIMITED WARRANTY

This warranty applies to all water systems pumps manufactured by Goulds Pumps.

Any part or parts found to be defective within the warranty period shall be replaced at no charge to the dealer during the warranty period. The warranty period shall exist for a period of twelve (12) months from date of installation or eighteen (18) months from date of manufacture, whichever period is shorter.

A dealer who believes that a warranty claim exists must contact the authorized Goulds Pumps distributor from whom the pump was purchased and furnish complete details regarding the claim. The distributor is authorized to adjust any warranty claims utilizing the Goulds Pumps Customer Service Department.

The warranty excludes:

- (a) Labor, transportation and related costs incurred by the dealer;
- (b) Reinstallation costs of repaired equipment;
- (c) Reinstallation costs of replacement equipment;
- (d) Consequential damages of any kind; and,
- (e) Reimbursement for loss caused by interruption of service.

For purposes of this warranty, the following terms have these definitions:

- (1) "Distributor" means any individual, partnership, corporation, association, or other legal relationship that stands between Goulds Pumps and the dealer in purchases, consignments or contracts for sale of the subject pumps.
- (2) "Dealer" means any individual, partnership, corporation, association, or other legal relationship which engages in the business of selling or leasing pumps to customers.
- (3) "Customer" means any entity who buys or leases the subject pumps from a dealer. The "customer" may mean an individual, partnership, corporation, limited liability company, association or other legal entity which may engage in any type of business.

THIS WARRANTY EXTENDS TO THE DEALER ONLY.

AQUAVAR, G&L Pumps and Goulds Pumps are tradenames and trademarks of ITT Industries and its subsidiaries.

www.goulds.com

Specifications subject to change without notice.